

# SAILOR 900 VSAT System





# SAILOR 900 VSAT

## Installation and user manual

**Document number:** 98-133400-F

**Release date:** 25 February 2013

## Disclaimer

Any responsibility or liability for loss or damage in connection with the use of this product and the accompanying documentation is disclaimed by Thrane & Thrane. The information in this manual is provided for information purposes only, is subject to change without notice and may contain errors or inaccuracies. Manuals issued by Thrane & Thrane are periodically revised and updated. Anyone relying on this information should acquire the most current version e.g. from [cobham.com/satcom](http://cobham.com/satcom) or from the distributor. Thrane & Thrane is not responsible for the content or accuracy of any translations or reproductions, in whole or in part, of this manual from any other source.

Thrane & Thrane A/S trading as Cobham SATCOM.

**Copyright © 2013 Thrane & Thrane A/S. All rights reserved.**

## Trademark acknowledgements

- **Thrane & Thrane** is a registered trademark of Thrane & Thrane A/S in the European Union and the United States.
- **SAILOR** is a registered trademark of Thrane & Thrane A/S in the European Union and the United States.
- **Windows** is a registered trademark of Microsoft Corporation in the United States and other countries.
- Other product and company names mentioned in this manual may be trademarks or trade names of their respective owners.

## GPL notification

The software included in this product contains copyrighted software that is licensed under the GPL/LGPL. The verbatim licenses can be found online at:

<http://www.gnu.org/licenses/old-licenses/gpl-2.0.html>

<http://www.gnu.org/licenses/old-licenses/lgpl-2.1.html>

You may obtain the complete corresponding source code from us for a period of three years after our last shipment of this product, which will be no earlier than 2021, by sending a money order or check for DKK 50 to:

SW Technology/GPL Compliance,  
Cobham SATCOM,  
Lundtoftegaardsvej 93D  
2800 Lyngby  
DENMARK

Please write "source for product SAILOR 900 VSAT" in the memo line of your payment.

You may also find a copy of the source at <http://www.thrane.com/foss>.

This offer is valid to anyone in receipt of this information.

## Safety summary

The following general safety precautions must be observed during all phases of operation, service and repair of this equipment. Failure to comply with these precautions or with specific warnings elsewhere in this manual violates safety standards of design, manufacture and intended use of the equipment. Cobham SATCOM assumes no liability for the customer's failure to comply with these requirements.

### Microwave radiation hazards

During transmission the Above Deck Unit (antenna) in this system radiates Microwave Power. This radiation may be hazardous to humans close to the Above Deck Unit. During transmission, make sure that nobody gets closer than the recommended minimum safety distance.

The minimum safety distance to the Above Deck Unit reflector on the focal line is 30 m, based on a radiation level of  $10 \text{ W/m}^2$ . No hazard exists  $>25^\circ$  below the Above Deck Unit's mounting plane. Refer to the drawing below.

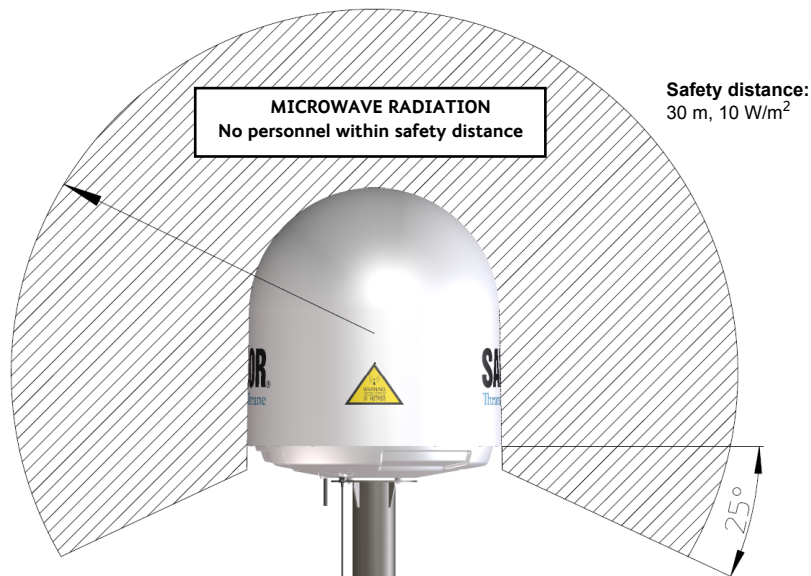

### No-transmit zones

In order to protect personnel no-transmit zones can be programmed. For further information see *Blocking zones — azimuth and elevation* on page 3-5.

### Distance to other equipment

Do not move the Above Deck Unit closer to radars than the minimum safe distance specified in section *Interference* on page 3-13 — it may cause damage to the Above Deck Unit.

### Compass Safe Distance:

SAILOR 900 VSAT antenna or ADU (Above Deck Unit): min. 130 cm (IEC 945).

SAILOR 900 VSAT ACU (Antenna Control Unit): min. 10 cm (IEC 945)

**Service**

User access to the interior of the ACU is prohibited. Only a technician authorized by Cobham SATCOM may perform service - failure to comply with this rule will void the warranty. Access to the interior of the Above Deck Unit is allowed. Replacement of certain modules and general service may only be performed by a technician authorized by Cobham SATCOM.

**Grounding, cables and connections**

To minimize shock hazard and to protect against lightning, the equipment chassis and cabinet must be connected to an electrical ground. The ACU must be grounded to the ship. For further grounding information refer to the Installation manual.

Do not extend the cables beyond the lengths specified for the equipment. The cable between the ACU and Above Deck Unit can be extended if it complies with the specified data concerning cable losses etc.

Rx and Tx cables for the SAILOR 900 VSAT system are shielded and should not be affected by magnetic fields. However, try to avoid running cables parallel to high power and AC/RF wiring as it might cause malfunction of the equipment.

**Power supply**

The voltage range for the SAILOR 900 VSAT is 20 — 32 VDC. Note that the Above Deck Unit is powered by the ACU.

If a 24 VDC power bus is not available, an external 115/230 VAC to 28 VDC power supply can be used, for example a SAILOR 6080 Power Supply.

**Do not operate in an explosive atmosphere**

Do not operate the equipment in the presence of flammable gases or fumes. Operation of any electrical equipment in such an environment constitutes a definite safety hazard.

**Keep away from live circuits**

Operating personnel must not remove equipment covers. Component replacement and internal adjustment must be made by qualified maintenance personnel. Do not replace components with the power cable connected. Under certain conditions, dangerous voltages may exist even with the power cable removed. To avoid injuries, always disconnect power and discharge circuits before touching them.

**Failure to comply with the rules above will void the warranty!**



**CAUTION!** Do not manually turn the Polarisation Unit of the antenna, it may cause damage to the antenna.

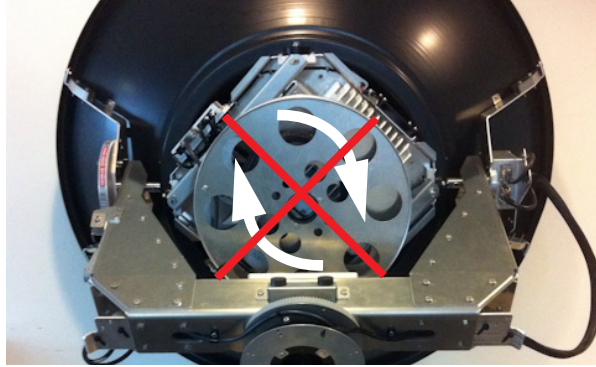

If needed to turn the Polarisation Unit manually, remove the connector (1) marked M of the Polarisation Motor Module (2).

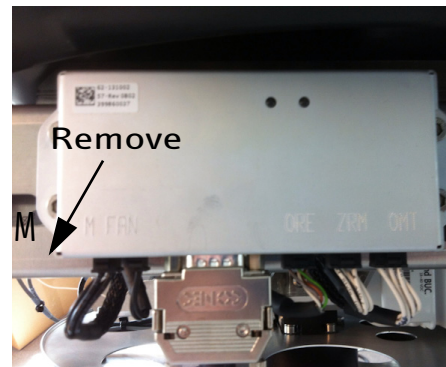
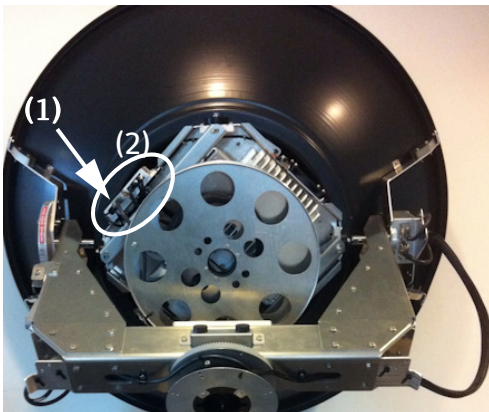

### VSAT restrictions

**Note**

There are restrictions in use of the frequency band 13.75 to 14 GHz in the following countries:

- Belgium
- Hungary
- Latvia
- Malta
- Slovakia

Contact VSAT modem provider for local setups.

# Record of Revisions

Rev.	Description	Release Date	Initials
A	Original document	26 September 2011	UFO
B	Sections added: 6.3.6, 6.3.7, 6.3.8, 9.4, Appendix B, Appendix C. - Sections edited: 1.2, 3.1.1, 3.2.6 (p. 3-10) 3.6.1, 4.1.7, 6.2.2, 6.3, 9.1.1. Figures added: 6-3, A-1, A-2. Figures edited: 2-4, 2-5, 6-4, 6-5, 6-6, 6-7, 6-14, 8-1, 9-10, 9-11. Tables have been edited: 2-1, 2-2, 6-5.	8 November 2011	UFO
C	Sections added: p.v (VSAT restrictions), 1.3, 3.32, App. D. Sections edited: 4.1.8, 4.1.10, 6.2.1, 6.2.2, 6.3.3, 6.3.4, 6.3.5, 6.3.6, 6.3.10. Figures edited: 2-4, 6-8, 6-9, 6-11, 6-17, 9-5, 9-10. Tables added: 6-5, 6-6. Tables edited: 6-3, 6-9, F-1, F-2	13 January 2012	UFO
D	Sections added: 6.2.3, App. D, App. H. Sections edited: p. v, 1.2, 1.3, 2.1.1, 4.1.8, 6.2.1, 6.3.10, 9.5. Figures added: 6-15. Figures edited: 4-5, 6-3, 6-5, 6-8, 6-9, 6-10, 6-25, 6-31, 8-1, 8-2, 9-4, 9-5. Tables added: A-5, A-6. Tables edited: 4.1, 6-8, 6-13, 7-2, E-1, G-1, G-2.	11 June 2012	UFO
E	Sections added: 3.7, 4.2.4, 4.2.5, 6.3.9, 6.5, C.5, D.2.2, D.2.3, F.7 Sections edited: 2.1, 3.1.1, 3.1.3, 3.3.3, 5.4, 6.2.1, 6.2.2, 6.3.5, 6.4.1, 9.2.2, C.1.3, F.2.1, F.3.2 Figures added: 3.22, 6-17, A-4, C-13 Figures edited: 6-9, 6-16, 6-21, 8-1 Tables added: 6-10 Tables edited: 2-2, 4-4, 6-9, 6-11, 7-2, A-4, C-4, E-1, G-1, G-2	31 October 2012	UFO
F	Sections added: 6.2.3, 8.2.2, A.1.5, C.1.4, C.3.2, C.4.3, C.5.3, C-6, H.2 Sections edited: ii, 1.3, 6.2.1., 6.2.2, 6.3.1, 6.3.4, 6.5, C.1.3 Figures added: 6-6, 6-12, 8-3, 8-4, 8-5, 8-6 Figures edited: 3-26, 6-2, 6-3, 6-4, 6-11, 6-14, 6-16, 6-26, 8-10, C-9, C-10 Tables have been added: 6-8 Tables have been edited: 2-1, 2-2, 3-8, 6-2, 6-6, A-6	25 February 2013	UFO



# Table of Contents

---

<b>Chapter 1</b>	<b>About this manual</b>	
	1.1 Intended readers .....	1-1
	1.2 Manual overview .....	1-1
	1.3 Software version .....	1-1
	1.4 Typography .....	1-2
	1.5 Precautions .....	1-2
<b>Chapter 2</b>	<b>Introduction</b>	
	2.1 SAILOR 900 VSAT system .....	2-1
	2.1.1 Above Deck Unit (ADU) .....	2-2
	2.1.2 Antenna Control Unit (ACU) .....	2-5
	2.1.3 VSAT Modem Unit (VMU) .....	2-7
	2.1.4 Satellite type approvals .....	2-7
	2.1.5 Power supply (optional) .....	2-7
	2.1.6 Service activation .....	2-7
	2.2 Part numbers and options .....	2-8
	2.2.1 Applicable Thrane & Thrane model and part numbers .....	2-8
	2.2.2 Options for SAILOR 900 VSAT .....	2-8
<b>Chapter 3</b>	<b>Installation</b>	
	3.1 Unpacking .....	3-1
	3.1.1 What's in the box .....	3-1
	3.1.2 Initial inspection .....	3-2
	3.1.3 Tools needed .....	3-2
	3.2 Site preparation .....	3-3
	3.2.1 General site considerations .....	3-3
	3.2.2 Obstructions (ADU shadowing) .....	3-4
	3.2.3 Blocking zones — azimuth and elevation .....	3-5
	3.2.4 Safe access to the ADU: Radiation hazard .....	3-6
	3.2.5 Ship motion and offset from the ship's motion centre .....	3-7
	3.2.6 ADU mast design: Foundation and height .....	3-8
	3.2.7 Interference .....	3-13
	3.2.8 Other precautions .....	3-17

- 3.3 Installation of the ADU** ..... 3-18
  - 3.3.1 Installing the ADU ..... 3-19
  - 3.3.2 Opening and removing the service hatch ..... 3-22
  - 3.3.3 Grounding the ADU ..... 3-23
  - 3.3.4 Alternative ADU cable ..... 3-24
- 3.4 Installation of the ACU** ..... 3-25
  - 3.4.1 Installing the 19" rack version of the ACU ..... 3-25
  - 3.4.2 Grounding the ACU ..... 3-25
- 3.5 Installation of the VMU** ..... 3-26
  - 3.5.1 General mounting considerations — VMU ..... 3-26
- 3.6 Installing the dual-antenna mode (optional)** ..... 3-27

**Chapter 4 Interfaces**

- 4.1 Interfaces of the SAILOR 900 VSAT ACU** ..... 4-1
  - 4.1.1 LEDs, display and keypad ..... 4-1
  - 4.1.2 ACU connector panel — overview ..... 4-1
  - 4.1.3 DC Input connector ..... 4-2
  - 4.1.4 ADU connector ..... 4-3
  - 4.1.5 Rx/Tx connectors for VMU ..... 4-3
  - 4.1.6 NMEA 0183 connector (RS-422) ..... 4-4
  - 4.1.7 RS-232 and RS-422 connectors ..... 4-5
  - 4.1.8 LAN1, LAN2, LAN3 and LAN4 connectors ..... 4-6
- 4.2 Interfaces of the VMU** ..... 4-7
  - 4.2.1 Connecting an iNFINITI® Series Satellite Router ..... 4-7
  - 4.2.2 Connecting an Evolution® Satellite Router ..... 4-8
  - 4.2.3 Connecting a COMTECH 570 L or 625 Satellite Modem ..... 4-8
  - 4.2.4 Connecting a Satlink 2900 VSAT modem ..... 4-10
  - 4.2.5 Connecting a Gilat SkyEdge II VSAT modem ..... 4-10

**Chapter 5 Connecting power**

- 5.1 Power source** ..... 5-1
- 5.2 Power cable selection** ..... 5-2
  - 5.2.1 Source impedance ..... 5-2
  - 5.2.2 Measuring the ship source impedance ..... 5-2
  - 5.2.3 Power cable recommendations ..... 5-3
- 5.3 Connecting power** ..... 5-4
- 5.4 Power up** ..... 5-5

---

<b>Chapter 6</b>	<b>Configuration</b>	
	<b>6.1 Introduction to the built-in web interface</b>	6-1
	6.1.1 Overview	6-1
	6.1.2 Connecting to the web interface	6-1
	<b>6.2 Calibration of the SAILOR 900 VSAT</b>	6-3
	6.2.1 Setup of a service profile for calibration	6-3
	6.2.2 Vessel heading & calibration of azimuth and cable	6-5
	6.2.3 Flow chart for azimuth and cable calibration	6-9
	6.2.4 Line up procedure	6-10
	6.2.5 SAILOR 900 VSAT fixed TX gain principle	6-12
	<b>6.3 Configuration with the web interface</b>	6-13
	6.3.1 Overview and dashboard	6-13
	6.3.2 Satellite profiles and VSAT modem profiles	6-19
	6.3.3 Setting up Blocking zones (RX and TX)	6-24
	6.3.4 Configuring the LAN network	6-26
	6.3.5 E-mail setup	6-29
	6.3.6 Sending statistics reports	6-30
	6.3.7 Sending a diagnostics report	6-33
	6.3.8 Dual antenna mode (optional)	6-34
	6.3.9 Upload	6-39
	6.3.10 Administration	6-39
	<b>6.4 Keypad and menus of the ACU</b>	6-45
	6.4.1 ACU display and keypad	6-45
	6.4.2 Navigating the menus	6-46
	6.4.3 The menu tree	6-46
	6.4.4 Adjusting brightness of the display	6-50
	6.4.5 Resetting the system	6-50
	<b>6.5 SNMP support</b>	6-51
<b>Chapter 7</b>	<b>Installation check</b>	
	<b>7.1 Installation check list: Antenna</b>	7-1
	<b>7.2 Installation check list: ACU, connectors and wiring</b>	7-3
	<b>7.3 Installation check list: Functional test in harbor</b>	7-5
<b>Chapter 8</b>	<b>Service</b>	
	<b>8.1 Getting support: Helpdesk</b>	8-2
	8.1.1 Help desk and diagnostic report	8-2

---

<b>8.2</b>	<b>Software update</b> .....	8-4
8.2.1	Hardware and software requirements .....	8-4
8.2.2	Software update (ADU and ACU) .....	8-4
8.2.3	Verifying the software update .....	8-7
<b>8.3</b>	<b>Status signalling with LEDs and status messages</b> .....	8-8
8.3.1	LEDs of the ADU modules .....	8-9
8.3.2	LEDs in the ACU .....	8-9
<b>8.4</b>	<b>Removal and replacement of the ACU</b> .....	8-10
<b>8.5</b>	<b>Removal and replacement of ADU modules</b> .....	8-11
<b>8.6</b>	<b>Troubleshooting</b> .....	8-14
8.6.1	Overview .....	8-14
8.6.2	Event list for troubleshooting .....	8-14
8.6.3	Diagnostic report for troubleshooting .....	8-14
<b>Appendix A</b>	<b>Technical specifications</b>	
<b>A.1</b>	<b>SAILOR 900 VSAT system components</b> .....	A-1
A.1.1	General specifications .....	A-1
A.1.2	ADU .....	A-2
A.1.3	ACU .....	A-4
A.1.4	Supported VSAT modems .....	A-5
A.1.5	Patents .....	A-5
<b>A.2</b>	<b>Outline drawings</b> .....	A-6
A.2.1	ADU .....	A-6
A.2.2	ACU (19 inch rack) .....	A-7
A.2.3	N-connector interface on the ADU .....	A-8
<b>A.3</b>	<b>VSAT LNB Data Sheet (physical LNB)</b> .....	A-9
A.3.1	VSAT LNB user installation and configuration information .....	A-10
<b>A.4</b>	<b>VSAT 8 W BUC Data Sheet (Extended)</b> .....	A-11
<b>Appendix B</b>	<b>VMU cables</b>	
<b>B.1</b>	<b>Modem Cable COMTECH Serial &amp; RSSI TT7016A</b> .....	B-2
<b>B.2</b>	<b>Modem Cable iNFINITI iDirect VSAT modem</b> .....	B-3
<b>Appendix C</b>	<b>VMU settings</b>	
<b>C.1</b>	<b>OpenAMIP setup for iDirect iNFINITI 5000 &amp; Evolution X5</b> .....	C-2
C.1.1	Protocol and interfaces .....	C-2
C.1.2	Sample options file .....	C-5
C.1.3	Configuration example (OpenAMIP) .....	C-7
C.1.4	Troubleshooting .....	C-8

<b>C.2</b>	<b>Serial setup for iDirect iNFINITI 5000 &amp; Evolution X5</b>	C-11
C.2.1	Protocol and interfaces	C-11
C.2.2	Console port settings	C-12
C.2.3	Configuration example (Serial)	C-14
<b>C.3</b>	<b>COMTECH 570L and ROSS box</b>	C-15
C.3.1	Protocols and interfaces	C-15
C.3.2	Configuration example (COMTECH 570L and ROSS)	C-16
<b>C.4</b>	<b>STM SatLink 2900 VSAT modem</b>	C-17
C.4.1	Interfaces and VSAT modem configuration	C-17
C.4.2	ACU configuration	C-18
C.4.3	Configuration example (STM Satlink 2900)	C-19
<b>C.5</b>	<b>Gilat SkyEdge II VSAT modem</b>	C-20
C.5.1	Interfaces and VSAT modem configuration	C-20
C.5.2	ACU configuration	C-21
C.5.3	Configuration example (Gilat SkyEdge II)	C-22
<b>C.6</b>	<b>Inmarsat G5 modem</b>	C-23
C.6.1	Interfaces and VSAT modem configuration	C-23
C.6.2	Connecting a Inmarsat G5 modem	C-23
C.6.3	Configuration example (Inmarsat G5)	C-23

## Appendix D Command line interface

<b>D.1</b>	<b>Introduction</b>	D-1
D.1.1	Telnet connection	D-1
D.1.2	Help	D-2
D.1.3	Conventions	D-2
<b>D.2</b>	<b>Supported commands</b>	D-3
D.2.1	config	D-3
D.2.2	demo	D-3
D.2.3	dual_antenna	D-4
D.2.4	exit	D-4
D.2.5	help	D-4
D.2.6	modem	D-5
D.2.7	satellite	D-5
D.2.8	status	D-7
D.2.9	system	D-8
D.2.10	track	D-8
D.2.11	zone	D-9

## Appendix E DVB-S satellites

---

<b>Appendix F</b>	<b>Grounding and RF protection</b>	
	<b>F.1 Why is grounding required?</b>	F-1
	F.1.1 Reasons for grounding	F-1
	F.1.2 Safety	F-1
	F.1.3 ESD Protection	F-1
	<b>F.2 Grounding Recommendations</b>	F-2
	F.2.1 Grounding the ACU	F-2
	F.2.2 Grounding the ADU	F-2
	<b>F.3 Alternative grounding for steel hulls</b>	F-3
	F.3.1 Grounding the ACU	F-3
	F.3.2 Grounding the ADU	F-4
	<b>F.4 Alternative grounding for aluminum hulls</b>	F-5
	F.4.1 Grounding the ACU	F-5
	F.4.2 Grounding the ADU	F-5
	<b>F.5 Alternative grounding for fibre glass hulls</b>	F-6
	F.5.1 Grounding the ACU	F-6
	F.5.2 Grounding the ADU	F-6
	<b>F.6 Separate ground cable</b>	F-7
	F.6.1 Ground cable - construction	F-7
	F.6.2 Ground cable - connection	F-8
	F.6.3 Isolation of the ADU from the mounting base	F-8
	<b>F.7 Jumper cable for grounding</b>	F-10
	<b>F.8 RF interference</b>	F-11
	F.8.1 Recommendations	F-11
<b>Appendix G</b>	<b>System messages</b>	
	<b>G.1 Event messages – overview</b>	G-1
	<b>G.2 List of ADU events</b>	G-2
	<b>G.3 List of ACU events</b>	G-8
<b>Appendix H</b>	<b>Approvals</b>	
	<b>H.1 Overview</b>	H-1
	<b>H.2 CE (R&amp;TTE)</b>	H-1
	<b>H.3 Eutelsat S.A – ESV Summary Sheet</b>	H-3
<b>Glossary</b>		Glossary-1
<b>Index</b>		Index-1

# List of Figures

---

## Chapter 1 About this manual

## Chapter 2 Introduction

Figure 2-1:	Above Deck Unit and Antenna Control Unit (ACU), 19" rack version .....	2-1
Figure 2-2:	Above Deck Unit (ADU).....	2-2
Figure 2-3:	Above Deck Unit modules 1/2 .....	2-3
Figure 2-4:	Above Deck Unit modules 2/2 .....	2-4
Figure 2-5:	SAILOR 900 VSAT ACU, connector overview .....	2-6
Figure 2-6:	SAILOR 900 VSAT ACU, 19" rack version.....	2-6
Figure 2-7:	Antenna Control Unit for 19" rack installation .....	2-7

## Chapter 3 Installation

Figure 3-1:	Signal degradation because of obstructing objects.....	3-4
Figure 3-2:	2 blocking zones with no-transmit zones, azimuth (example).....	3-5
Figure 3-3:	Blocking zone with no-transmit zones, elevation angle (example).....	3-5
Figure 3-4:	Radiation hazard, safety distance 30 m .....	3-6
Figure 3-5:	Maximum distance from the ship's motion centre (h max) .....	3-7
Figure 3-6:	ADU mast flange, top and side view .....	3-8
Figure 3-7:	ADU mast flange, recommended flatness on the mast mount plateau.....	3-8
Figure 3-8:	ADU mast flange, distance to the welded seam.....	3-9
Figure 3-9:	ADU, bottom view .....	3-9
Figure 3-10:	Free mast length and bracing for a tall mast.....	3-10
Figure 3-11:	Interference with the vessel's radar .....	3-13
Figure 3-12:	Recommended distance to transmitters (m) for frequencies below 1000 MHz.....	3-16
Figure 3-13:	Drain pipe with free space .....	3-17
Figure 3-14:	Use of strong sling with a belt and tag lines for safe hoisting.....	3-18
Figure 3-15:	Free space for access to the service hatch .....	3-19
Figure 3-16:	ADU installation, webbed sling attached to the 4 lifting brackets .....	3-20
Figure 3-17:	Mounting the ADU on the mast flange .....	3-20
Figure 3-18:	Connecting the ADU cable .....	3-21
Figure 3-19:	Opening the service hatch .....	3-22
Figure 3-20:	Removing the 2 split pins .....	3-22
Figure 3-21:	ADU, bolt for optimum grounding.....	3-23
Figure 3-22:	ACU, 19" rack version, On/off switch at the back.....	3-25
Figure 3-23:	ACU, LAN connector at the front: Service port .....	3-25
Figure 3-24:	ACU, 19" rack version, ground stud.....	3-26
Figure 3-25:	Dual mode antenna, overview.....	3-27
Figure 3-26:	Dual mode antenna, connecting cables (example).....	3-28

**Chapter 4 Interfaces**

Figure 4-1:	ACU — LEDs, display and keypad .....	4-1
Figure 4-2:	ACU: LEDs, display and keypad (detailed) .....	4-1
Figure 4-3:	ACU rack version, connector panel overview .....	4-1
Figure 4-4:	DC Input connector with power cable.....	4-2
Figure 4-5:	LAN1 —LAN4 connectors.....	4-6
Figure 4-6:	Connecting an iFINITI® Series Satellite Router.....	4-7
Figure 4-7:	Connecting an Evolution Satellite Router.....	4-8
Figure 4-8:	Connecting a COMTECH 570 L or 625 Satellite Modem.....	4-8
Figure 4-9:	Connecting a SatLink 2900 Modem .....	4-10
Figure 4-10:	Connecting a Gilat SkyEdge II VSAT Modem.....	4-10

**Chapter 5 Connecting power**

Figure 5-1:	Measuring the ship source impedance .....	5-2
Figure 5-2:	Connecting power to DC Input.....	5-4
Figure 5-3:	ACU display after first power on (example with LAN ports 1 and 4 used).....	5-5

**Chapter 6 Configuration**

Figure 6-1:	LAN connector used for configuring the SAILOR 900 VSAT .....	6-1
Figure 6-2:	SAILOR 900 VSAT Dashboard.....	6-2
Figure 6-3:	Service profile for calibration .....	6-4
Figure 6-4:	Web interface: SERVICE, Calibration .....	6-5
Figure 6-5:	Web interface: SERVICE, Calibration, cable attenuator margin .....	6-7
Figure 6-6:	Example for azimuth and cable calibration — step by step.....	6-9
Figure 6-7:	Web interface: SERVICE, Line up: Ready for activation .....	6-10
Figure 6-8:	Web interface: SERVICE, Line up: Antenna ready.....	6-11
Figure 6-9:	Fixed TX gain principle.....	6-12
Figure 6-10:	Topics in the web interface (SITE MAP) .....	6-13
Figure 6-11:	Web interface: DASHBOARD .....	6-14
Figure 6-12:	Web interface: DASHBOARD, TX - BUC output power (example).....	6-18
Figure 6-13:	Web interface: SETTINGS - list of satellite profiles (example).....	6-19
Figure 6-14:	Web interface: SETTINGS, Satellite profiles — new entry (example).....	6-20
Figure 6-15:	Web interface: SETTINGS, VSAT modem profiles — list (example).....	6-22
Figure 6-16:	Web interface: SETTINGS, VSAT modem profile – supported modems.....	6-22
Figure 6-17:	Satellite profile for generic modem.....	6-23
Figure 6-18:	Web interface: SETTINGS, Blocking zones — azimuth and elevation .....	6-24
Figure 6-19:	Blocking zone, example: 315 - 45 degrees .....	6-25
Figure 6-20:	Blocking zone, example: 45 - 315 degrees .....	6-25
Figure 6-21:	Web interface: SETTINGS, Network (default settings).....	6-26
Figure 6-22:	Web interface: SETTINGS, E-mail setup (example) .....	6-29
Figure 6-23:	Web interface: SETTINGS, Reports (example) .....	6-30
Figure 6-24:	Statistics — how to read data for a range .....	6-32



Figure 6-25:	Statistics report (example).....	6-33
Figure 6-26:	Dual-antenna mode, link on DASHBOARD.....	6-34
Figure 6-27:	Enabling dual-antenna mode in Master ACU.....	6-35
Figure 6-28:	Dual-antenna mode, add Slave modem profile.....	6-36
Figure 6-29:	Dual-antenna mode, add Slave satellite profile.....	6-36
Figure 6-30:	Dual-antenna mode, Activate.....	6-37
Figure 6-31:	Dual-antenna mode, blocking zones — azimuth and elevation.....	6-38
Figure 6-32:	Dual-antenna mode, line up.....	6-39
Figure 6-33:	Web interface: Administration.....	6-40
Figure 6-34:	Web interface: Administration, change administrator logon and password.....	6-40
Figure 6-35:	Web interface: ADMINISTRATION, Reset administrator password.....	6-41
Figure 6-36:	Web interface: ADMINISTRATION, User permissions.....	6-42
Figure 6-37:	Web interface: Administration, Export/import configuration.....	6-43
Figure 6-38:	Web interface: ADMINISTRATION, Factory default.....	6-44
Figure 6-39:	Display (example) and keypad of the ACU.....	6-45
Figure 6-40:	Antenna Control Unit, menu tree.....	6-46
Figure 6-41:	Reset the system.....	6-50

## **Chapter 7 Installation check**

## **Chapter 8 Service**

Figure 8-1:	Web interface: HELPDESK.....	8-2
Figure 8-2:	Web interface: HELPDESK, Event list.....	8-3
Figure 8-3:	LAN connector used for software update (TMA).....	8-4
Figure 8-4:	SAILOR 900 VSAT connected: Software update with the TMA.....	8-5
Figure 8-5:	LAN connector used for software update (web interface).....	8-6
Figure 8-6:	Software update with the web interface.....	8-6
Figure 8-7:	Verifying software update.....	8-7
Figure 8-8:	LEDs on the ACU.....	8-9
Figure 8-9:	Removal and replacement of the ACU 19" rack.....	8-10
Figure 8-10:	ADU modules and motor stop switch.....	8-11
Figure 8-11:	Above Deck Unit modules (continued).....	8-13

## **App. A Technical specifications**

Figure A-1:	Outline drawing: ADU.....	A-6
Figure A-2:	Outline drawing: ACU, 19 inch rack.....	A-7
Figure A-3:	N-Connector interface on the ADU.....	A-8

## **App. B VMU cables**

Figure B-1:	Modem Cable COMTECH Serial & RSSI TT7016A.....	B-2
Figure B-2:	Modem Cable iNFINITI iDirect VSAT modem.....	B-3

## **App. C VMU settings**

Figure C-1:	Connecting iDirect iNFINITI 5000 series to the ACU (OpenAMIP) .....	C-2
Figure C-2:	Connecting iDirect Evolution X5 to the ACU (OpenAMIP).....	C-3
Figure C-3:	Supported OpenAMIP commands .....	C-3
Figure C-4:	VSAT modem profile, OpenAMIP (example) .....	C-7
Figure C-5:	Satellite profile, OpenAMIP (example).....	C-7
Figure C-6:	iDirect OpenAMIP troubleshooting.....	C-9
Figure C-7:	Connecting iDirect iNFINITI 5000 series to the ACU (Serial).....	C-11
Figure C-8:	Connecting iDirect Evolution X5 to the ACU (Serial).....	C-11
Figure C-9:	VSAT modem profile, Serial (example).....	C-14
Figure C-10:	Satellite profile, Serial (example) .....	C-14
Figure C-11:	Connecting COMTECH 570L and ROSS box to the ACU (example).....	C-15
Figure C-12:	VSAT modem profile, COMTECH 570L and ROSS (example).....	C-16
Figure C-13:	Satellite profile, COMTECH 570L and ROSS (example).....	C-16
Figure C-14:	Connecting STM SatLink 2900 VSAT modem to the ACU .....	C-17
Figure C-15:	VSAT modem profile, STM SatLink 2900 (example).....	C-19
Figure C-16:	Satellite profile, STM SatLink 2900 (example).....	C-19
Figure C-17:	Connecting Gilat SkyEdge II VSAT modem to the ACU .....	C-20
Figure C-18:	VSAT modem profile, Gilat Sky Edge II (example).....	C-22
Figure C-19:	Satellite profile, Gilat Sky Edge II (example).....	C-22
Figure C-20:	VSAT modem profile, Inmarsat G5 (example).....	C-23
Figure C-21:	Satellite profile, Inmarsat G5 (example).....	C-23

## **App. D Command line interface**

Figure D-1:	How to use the command line interface (example for telnet).....	D-1
Figure D-2:	Command line interface, login.....	D-2

## **App. E DVB-S satellites**

Figure E-1:	Satellite data, example from <a href="http://www.lyngsat.com">www.lyngsat.com</a> .....	E-2
-------------	---	-----

## **App. F Grounding and RF protection**

Figure F-1:	Extending the ground plane.....	F-2
Figure F-2:	Grounding the ADU.....	F-3
Figure F-3:	Grounding at a dedicated RF ground (alternative).....	F-4
Figure F-4:	Alternative grounding for aluminium hulls.....	F-5
Figure F-5:	Alternative grounding for fibreglass hulls.....	F-6
Figure F-6:	Separate ground cable .....	F-7
Figure F-7:	Isolation of the ADU from the mounting base.....	F-8
Figure F-8:	ADU isolation and grounding cable.....	F-9
Figure F-9:	Jumper cable for grounding (specifications).....	F-10

## **App. G System messages**

## **App. H Approvals**

# List of Tables

---

## Chapter 1 About this manual

## Chapter 2 Introduction

Table 2-1:	Model and part numbers for the SAILOR 900 VSAT system.....	2-8
Table 2-2:	Model and part numbers for options of the SAILOR 900 VSAT system .....	2-8

## Chapter 3 Installation

Table 3-1:	Maximum distance from the ship's motion center versus ship's roll period.....	3-7
Table 3-2:	Mast dimensions without braces.....	3-11
Table 3-3:	Mast dimensions with 3 braces .....	3-11
Table 3-4:	Mast dimensions with 2 braces .....	3-12
Table 3-5:	Minimum radar separation, X-band .....	3-14
Table 3-6:	Minimum radar separation, S-band .....	3-14
Table 3-7:	ADU cable types and maximum lengths.....	3-24
Table 3-8:	Dual mode antenna, cabling.....	3-28

## Chapter 4 Interfaces

Table 4-1:	DC Input plug, outline and pin assignment.....	4-2
Table 4-2:	N connector, outline and pin assignment.....	4-3
Table 4-3:	F connector, Rx and Tx, outline and pin assignment .....	4-3
Table 4-4:	NMEA 0183/2000 connector, outline and pin assignment.....	4-4
Table 4-5:	RS-232 connector, male, outline and pin assignment.....	4-5
Table 4-6:	RS-422 connector, male, outline and pin assignment.....	4-6
Table 4-7:	Ethernet connector, outline and pin assignment.....	4-7
Table 4-8:	Cables to connect an iNFINITI® Series Satellite Router .....	4-8
Table 4-9:	Cables to connect a COMTECH 570 L-Band Satellite Modem.....	4-9
Table 4-10:	Cables to connect a SatLink 2900 VSAT modem.....	4-10
Table 4-11:	Cables to connect a Gilat SkyEdge VSAT modem.....	4-10

## Chapter 5 Connecting power

## Chapter 6 Configuration

Table 6-1:	Satellite requirements for elevation and carrier .....	6-4
Table 6-2:	Satellite identifier and NID values.....	6-7
Table 6-3:	Possible error codes during calibration .....	6-8
Table 6-4:	Web interface: Event icon.....	6-15
Table 6-5:	Web interface, DASHBOARD, SAILOR 900 VSAT parameters.....	6-16
Table 6-6:	Web interface, DASHBOARD, VSAT MODEM parameter.....	6-17

Table 6-7:	Web interface, DASHBOARD, POINTING parameter .....	6-18
Table 6-8:	Web interface, DASHBOARD, TX parameter .....	6-18
Table 6-9:	Elevation cutoff (in degrees) versus VSAT modem bandwidth and power .....	6-21
Table 6-10:	Setup of LAN connectors .....	6-27
Table 6-11:	Statistics report, header record .....	6-31
Table 6-12:	Parameters recorded in a statistics report.....	6-31
Table 6-13:	Top-level menus of the ACU .....	6-47
Table 6-14:	ANTENNA menu of the ACU .....	6-47
Table 6-15:	MODEM menu of the ACU .....	6-48
Table 6-16:	NETWORK menu of the ACU.....	6-48
Table 6-17:	SATELLITE menu of the ACU .....	6-49
Table 6-18:	EVENTS menu of the ACU.....	6-49

## Chapter 7 Installation check

Table 7-1:	Installation check list: Antenna.....	7-1
Table 7-2:	Installation check list: ACU, connectors and wiring .....	7-3
Table 7-3:	Installation check list: Functional test in harbour .....	7-5

## Chapter 8 Service

Table 8-1:	LEDs of the ADU modules.....	8-9
Table 8-2:	LEDs on the ACU.....	8-9

## App. A Technical specifications

Table A-1:	General specifications.....	A-1
Table A-2:	Technical specifications for the Above Deck Unit.....	A-2
Table A-3:	Technical specifications for the ACU .....	A-4
Table A-4:	Supported VSAT modems.....	A-5
Table A-5:	Patents.....	A-5
Table A-6:	Technical specifications for VSAT LNB 1/2 .....	A-9
Table A-7:	Technical specifications for VSAT LNB 2/2 .....	A-9
Table A-8:	4-band switching.....	A-11
Table A-9:	Technical specifications for VSAT 8 W BUC 1/2 .....	A-11
Table A-10:	Technical specifications for VSAT 8 W BUC 2/2 .....	A-11

## App. B VMU cables

### App. C VMU settings

Table C-1:	Messages sent from the VSAT modem to the ACU (examples).....	C-3
Table C-2:	Messages sent from the ACU to the VSAT modem (examples).....	C-4
Table C-3:	Ranges for signal strength for iDirect OpenAMIP VSAT modem.....	C-4
Table C-4:	Information in the VSAT modem option file .....	C-6
Table C-5:	RS-232 Console cable for iDirect Serial VSAT modem.....	C-12

---

Table C-6:	Requirements for VSAT modem option file, Serial .....	C-13
Table C-7:	Configuration of Gilat SkyEdge II VSAT modem.....	C-20
<b>App. D</b>	<b>Command line interface</b>	
Table D-1:	Command typography.....	D-2
Table D-2:	UCLI command: <code>config</code> .....	D-3
Table D-3:	UCLI command: <code>demo</code> .....	D-3
Table D-4:	UCLI command: <code>dual_antenna</code> .....	D-4
Table D-5:	UCLI command: <code>exit</code> .....	D-4
Table D-6:	UCLI command: <code>help</code> .....	D-4
Table D-7:	UCLI command: <code>modem</code> .....	D-5
Table D-8:	UCLI command: <code>satellite</code> .....	D-5
Table D-9:	UCLI command: <code>status</code> .....	D-7
Table D-10:	UCLI command: <code>system</code> .....	D-8
Table D-11:	UCLI command: <code>track</code> .....	D-8
Table D-12:	UCLI command: <code>zone</code> .....	D-9
<b>App. E</b>	<b>DVB-S satellites</b>	
Table E-1:	Examples of DVB-S satellites for azimuth calibration.....	E-1
<b>App. F</b>	<b>Grounding and RF protection</b>	
<b>App. G</b>	<b>System messages</b>	
Table G-1:	ADU event messages.....	G-2
Table G-2:	ACU event messages .....	G-8
<b>App. H</b>	<b>Approvals</b>	



# About this manual

## 1.1 Intended readers

This is an installation manual for the SAILOR 900 VSAT system, intended for installers of the system and service personnel. Personnel installing or servicing the system must be properly trained and authorized by Cobham SATCOM. It is important that you observe all safety requirements listed in the beginning of this manual, and install the system according to the guidelines in this manual.

## 1.2 Manual overview

This manual has the following chapters:

- *Introduction*
- *Installation*
- *Interfaces*
- *Connecting power*
- *Configuration*
- *Installation check*
- *Service*

This manual has the following appendices:

- *Technical specifications*
- *VMU cables*
- *VMU settings*
- *Command line interface*
- *DVB-S satellites*
- *Grounding and RF protection*
- *System messages*
- *Approvals*

## 1.3 Software version

This manual is intended for SAILOR 900 VSAT with **software version 1.41**.

## 1.4 Typography

In this manual, typography is used as indicated below:

**Bold** is used for the following purposes:

- To emphasize words.  
Example: “Do **not** touch the antenna”.
- To indicate what the user should select in the user interface.  
Example: “Select **SETTINGS** > **LAN**”.

**Italic** is used to emphasize the paragraph title in cross-references.

Example: “For further information, see *Connecting Cables* on page...”.

## 1.5 Precautions

### Warnings, Cautions and Notes

Text marked with “Warning”, “Caution”, “Note” or “Important” show the following type of data:

- **Warning:** A Warning is an operation or maintenance procedure that, if not obeyed, can cause injury or death.
- **Caution:** A Caution is an operation or maintenance procedure that, if not obeyed, can cause damage to the equipment.
- **Note:** A Note gives information to help the reader.
- **Important:** A text marked Important gives information that is important to the user, e.g. to make the system work properly. This text does not concern damage on equipment or personal safety.

### General precautions

All personnel who operate equipment or do maintenance as specified in this manual must know and follow the safety precautions. The warnings and cautions that follow apply to all parts of this manual.



**WARNING!** Before using any material, refer to the manufacturers’ material safety data sheets for safety information. Some materials can be dangerous.



**CAUTION!** Do not use materials that are not equivalent to materials specified by Thrane & Thrane. Materials that are not equivalent can cause damage to the equipment.



**CAUTION!** The system contains items that are electrostatic discharge sensitive. Use approved industry precautions to keep the risk of damage to a minimum when you touch, remove or insert parts or assemblies.



# Introduction

This chapter is organised in the following sections:

- *SAILOR 900 VSAT system*
- *Part numbers and options*

## 2.1 SAILOR 900 VSAT system

The SAILOR 900 VSAT is a unique stabilized maritime VSAT antenna system operating in the Ku-band (10.7 to 14.5 GHz). It provides bi-directional IP data connections both on regional satellite beams and quasi-global Ku-band satellite networks. The system only requires a single 50 Ohm cable to provide the Above Deck Unit with both DC power, data and control information. The radome does not have to be removed neither before nor after the installation. To protect the Above Deck Unit the built-in DC motors act as brakes during transport and when the Above Deck Unit is not powered. The ADU system can be accessed remotely and in-depth performance analysis can be done using the built-in web interface.

The SAILOR 900 VSAT system consists of two units:

- Above Deck Unit (ADU)
- Antenna Control Unit (ACU)

The following figure shows the SAILOR 900 VSAT system.



Figure 2-1: Above Deck Unit and Antenna Control Unit (ACU), 19" rack version

### SAILOR 900 VSAT features

- Single 50 Ohm coax cable for the ADU.
- Support of several VSAT modems.
- Dual antenna mode.

- SNMP support.
- Service communication using SAILOR FleetBroadband over WAN.
- Remote or local simultaneous software update of ADU and ACU via PC and Internet browser.
- Global RF configuration.
- Full remote control and troubleshooting with built-in test equipment (BITE).
- ACU with 4 x LAN, NMEA 0183, NMEA 2000, RS-232 and RS-422.
- All interfaces at the ACU, no additional units required.
- DC powered. Start up voltage: 22 VDC guaranteed, operating range: 20 – 32 VDC.
- No scheduled maintenance.

### 2.1.1 Above Deck Unit (ADU)

The SAILOR 900 VSAT ADU is a 103 cm VSAT stabilised tracking antenna, consisting of a suspended antenna with a standard global RF configuration. The ADU's weight is 130 kg. It is stabilized by heavy duty vibration dampers in 3-axis (plus skew) and can be used in environments with elevations of  $-25^{\circ}$  to  $+125^{\circ}$ . The ADU is powered by the ACU and protected by a radome.



Figure 2-2: Above Deck Unit (ADU)

## Modules in the SAILOR 900 VSAT ADU

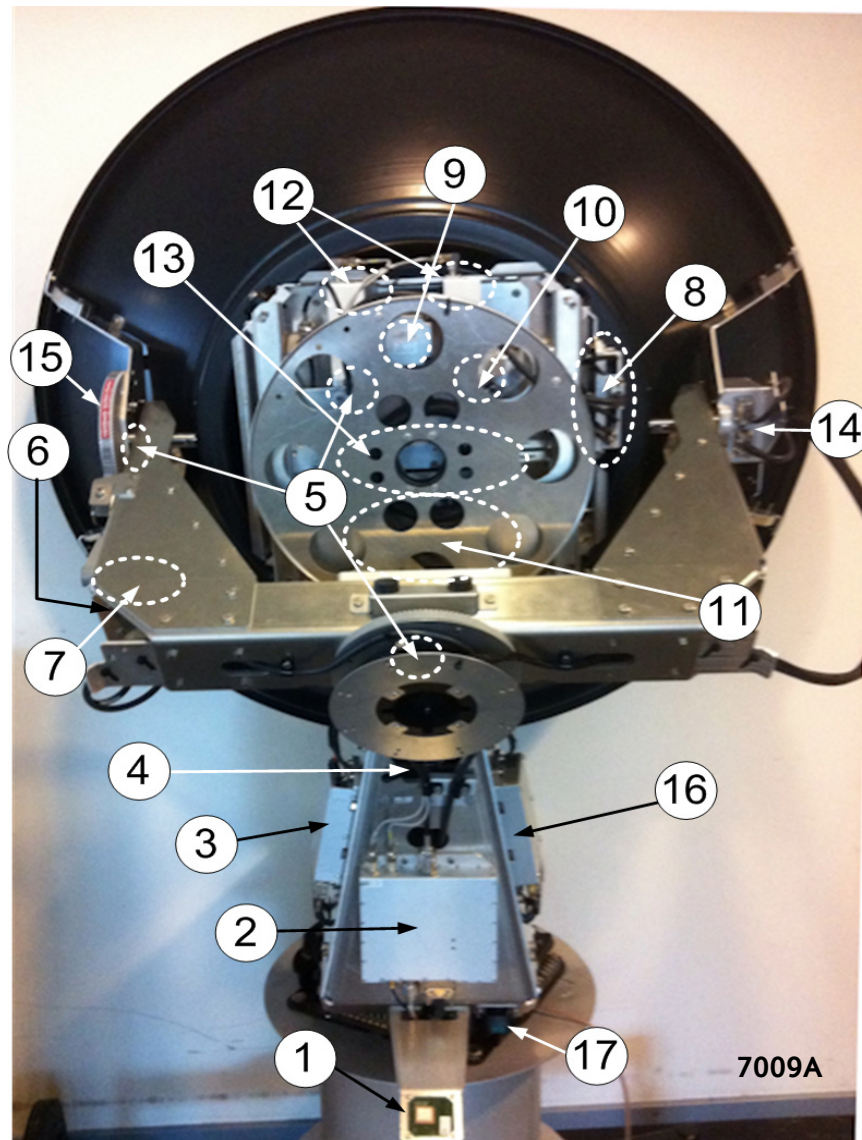

Figure 2-3: Above Deck Unit modules 1/2

1. GPS module.
2. VSAT Interface Module (VIM).
3. DC-Motor Driver Module for cross elevation (DDM).
4. Cross elevation motor and encoder.
5. Zero Reference Module (x4) (ZRM) (not visible on photo).
6. DC-Motor Driver Module for elevation (on the bottom) (DDM).
7. Elevation motor and encoder (not visible).
8. Polarisation Motor Module (PMM).
9. Polarisation motor.
10. Polarisation encoder (not visible on photo).

- 11. Block Up Converter (BUC). (behind cable screen, not visible on photo)
- 12. Low Noise Block downconverter (x2) (LNB).
- 13. Ortho Mode Transducer (OMT). (not visible on photo)
- 14. Inertial Sensor Module (ISM).
- 15. Elevation locking pin to lock the antenna dish in a fixed position.
- 16. Pedestal Control Module (PCM).
- 17. Service switch.

In switch-off position the DC Motor Driver modules and the BUC are turned off for safe conditions during service and repair. The switch must be in on position for normal ADU operation.

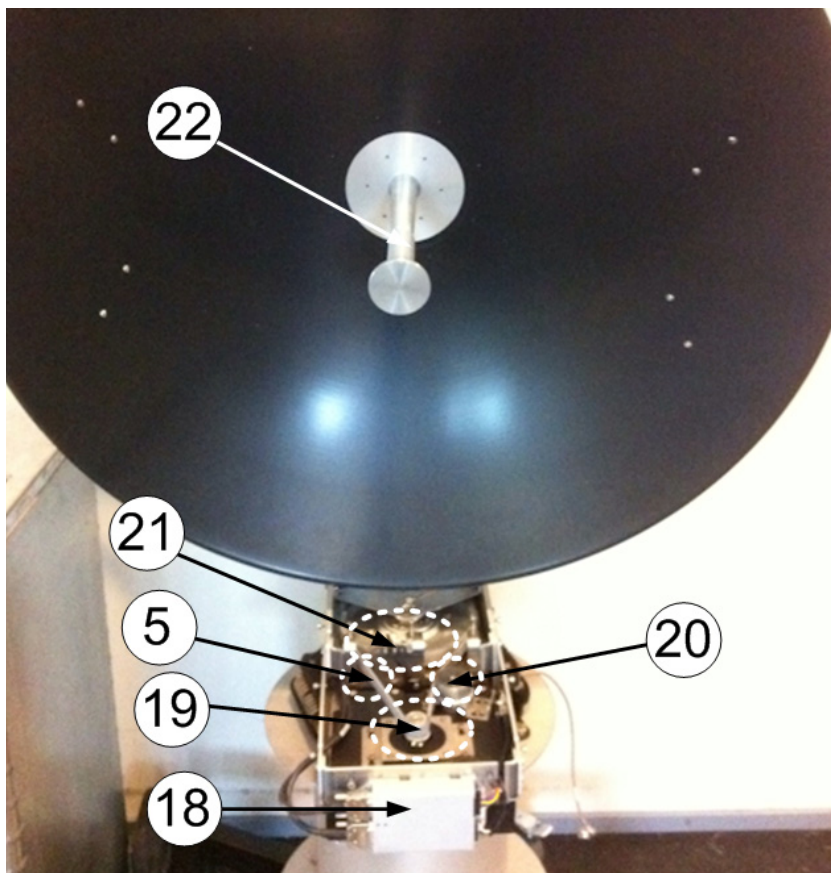

Figure 2-4: Above Deck Unit modules 2/2

- 18. DC-Motor Driver Module for Azimuth (DDM).
- 19. Azimuth motor.
- 20. Azimuth encoder.
- 21. Rotary joint.
- 22. Feed horn.

## SAILOR 900 VSAT ADU interface

All communication between the ADU and the ACU passes through a single standard 50 Ohm cable (with N connector) through the rotary joint. No cable work is required inside the radome.

### Installation friendly

Four lifting brackets (included in the delivery) and reuse of packing material help getting the ADU safely into place. Satellite profile parameters are entered using the built-in web server of the ACU, using a PC.

### Service friendly

The system configuration is saved in two modules, there is no loss of data at repair. The large service hatch of the radome gives easy access to the ADU on site. The service switch in the ADU stops the DC Motor Driver modules and turns the BUC off. The service tools for replacing modules are placed on a tool holder inside the radome.

All modules have a service and power LED status indicator. Each module is encapsulated in a metal box with self-contained mounting bolts.

If necessary, belts and modules can be exchanged through the service hatch on site.

You can do remote diagnostics and service with the ADU. Its built-in test equipment checks constantly the ADU's components for proper functioning, it monitors and logs information for all modules. The ADU performs a POST (Power On Self Test) and you can request a self test (PAST, Person Activated Self Test) and Continuous Monitoring (CM). Error codes can be read out in the web interface and in the display of the ACU.

ADU software is updated automatically when making a software update of the ACU.

## 2.1.2 Antenna Control Unit (ACU)

The ACU is the central unit in the system. It contains all user interfaces and manages all communication between the ADU and connected the VMU, a connected PC and an optional FleetBroadband service communication line. The ACU has a display, status LEDs and a keypad. It provides a DHCP client. During configuration you can configure heading offset, save satellite and VMU setups and enter *No Transmit Zones* (blocking zones in which the ADU does not transmit).

The ACU provides DC power to the ADU through a single coaxial cable. You can use the SAILOR 6080 Power Supply to provide the DC power for the ACU.

## ACU interfaces

The ACU has the following interfaces and switch:

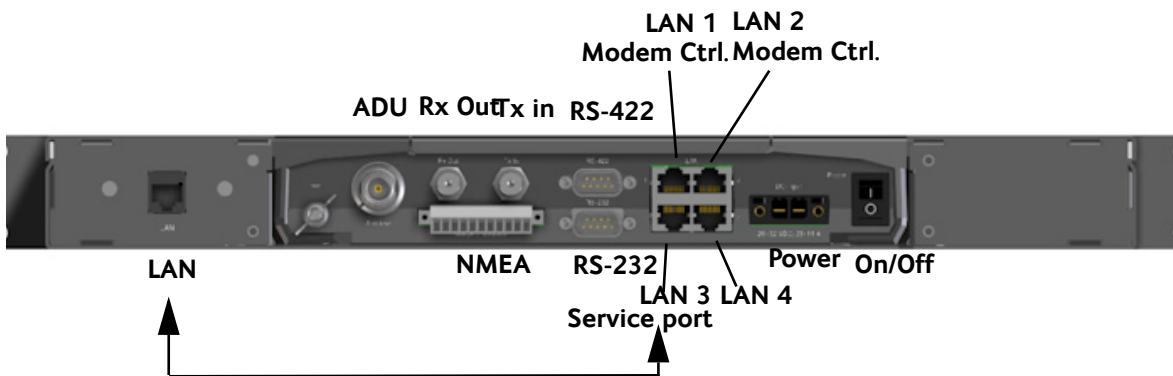

Figure 2-5: SAILOR 900 VSAT ACU, connector overview

- N-connector for ADU cable (50 Ohm).
- 2 x F connectors for Rx and Tx cables (75 Ohm) to VSAT modem.
- Multi connector for NMEA interfaces (for input from GPS compass or Gyro compass).
- RS-422 interface for modem control.
- RS-232 interface for modem control.
- 4 x LAN ports for VSAT modem control and user equipment (i.e. for SAILOR FleetBroadband service communication line or WAN port for VSAT Internet).
- Power connector.
- On/Off power switch

The ACU has additionally a LAN connector at the front for accessing the service port from the ACU front panel.



Figure 2-6: SAILOR 900 VSAT ACU, 19" rack version

## Installation friendly

The ACU comes in a 19" rack version.



Figure 2-7: Antenna Control Unit for 19" rack installation

## Service friendly

You can do remote diagnostics and service with the ACU. Its built-in test equipment checks constantly the ACU's modules for proper functioning, it monitors and logs for all modules. It performs POST (Power On Self Test) and you can request a PAST (Person Activated Self Test). Continuous Monitoring (CM) is also available. BITE error codes can be read out in the web interface and in the display of the ACU.

Software update is done via a connected PC and the built-in web interface of the ACU.

### 2.1.3 VSAT Modem Unit (VMU)

SAILOR 900 VSAT is designed to be operated with third-party VSAT modems. For a list of supported VSAT modems see the SAILOR 900 VSAT data sheet at [cobham.com/satcom](http://cobham.com/satcom).

### 2.1.4 Satellite type approvals

For a list of satellite type approvals see the SAILOR 900 VSAT data sheet at [cobham.com/satcom](http://cobham.com/satcom).

### 2.1.5 Power supply (optional)

Use the SAILOR 6080 AC/DC Power Supply to provide DC power to the SAILOR 900 VSAT.

### 2.1.6 Service activation

Before you can start using the SAILOR 900 VSAT, you need to activate the system for VSAT service. Contact your service provider for activation.

## 2.2 Part numbers and options

### 2.2.1 Applicable Thrane & Thrane model and part numbers

The following model and part numbers are available for the SAILOR 900 VSAT system:

T&T part number	Model number	Description
407009A-00500	TT-7009A-THR	SAILOR 900 VSAT Above Deck Unit (ADU)
407016A-00500	TT-7016A-T19	SAILOR 900 VSAT Antenna Control Unit (19 inch rack)

Table 2-1: Model and part numbers for the SAILOR 900 VSAT system

### 2.2.2 Options for SAILOR 900 VSAT

The following options are available for the SAILOR 900 VSAT system:

Part number	Description
406080A-00500	SAILOR 6080 AC/DC Power Supply
407090A-950	Antenna cable 50 m, N-Conn (not mounted), male/male
407090A-925	Pigtail Cable 1.25 m, N-Conn, female/male
407090-010	Accessory kit for dual antenna mode

Table 2-2: Model and part numbers for options of the SAILOR 900 VSAT system



# Installation

This chapter is organised in the following sections:

- *Unpacking*
- *Site preparation*
- *Installation of the ADU*
- *Installation of the ACU*
- *Installation of the VMU*

## 3.1 Unpacking

### 3.1.1 What's in the box

#### ADU

Unpack your SAILOR 900 VSAT ADU and check that the following items are present:

- ADU with 4 lifting brackets (already mounted)
- Package with bolts, washers and cable glands (2 sizes)

#### ACU

Unpack your SAILOR 900 VSAT ACU (19" rack version) and check that the following items are present:

- 1 x Ethernet cable (2 m)
- 1 x Ethernet cable (short)
- Power connector
- 2 x 75 Ohm coax cables F-F (1m), for Rx and Tx
- NMEA multi-connector
- Installation manual (this manual)

### 3.1.2 Initial inspection

Inspect the shipping cartons and wooden box immediately upon receipt for evidence of damage during transport. If the shipping material is severely damaged or water stained, request that the carrier's agent be present when opening the cartons and wooden box. Save all box packing material for future use.



**WARNING!** To avoid electric shock, do not apply power to the system if there is any sign of shipping damage to any part of the front or rear panel or the outer cover. Read the safety summary at the front of this manual before installing or operating the system.

After unpacking the system, i.e. removing the top and sides of the wooden box and opening the cartons, inspect it thoroughly for hidden damage and loose components or fittings. If the contents are incomplete, if there is mechanical damage or defect, or if the system does not work properly, notify your dealer.

### 3.1.3 Tools needed

- Unbraco key (5 mm), included, mounted on a tool holder inside the radome.

Other tools that may be needed during the installation:

- Torx TX20 to open the locks of the service hatch
- Wrench to fasten the mounting bolts for the ADU
- Wrench to fasten the N connector at the ADU
- PC and Internet browser
- Drill for the mounting holes for the ACU
- Crimping tools

## 3.2 Site preparation

The following topics have to be considered when installing the ADU:

- *General site considerations*
- *Obstructions (ADU shadowing)*
- *Blocking zones — azimuth and elevation*
- *Safe access to the ADU: Radiation hazard*
- *Ship motion and offset from the ship's motion centre*
- *ADU mast design: Foundation and height*
- *Interference*
- *Other precautions*

### 3.2.1 General site considerations

For optimum system performance, some guidelines on where to install or mount the different components of the SAILOR 900 VSAT System must be followed.

It is recommended to mount the ADU in a location with as much **360° free line of sight to the satellite** as possible while making sure that the support structure fulfills the requirements for the mast foundation. The ADU must be mounted on stiffened structures with a minimum of exposure to vibrations.

### 3.2.2 Obstructions (ADU shadowing)

Place the ADU so that it has as much free line-of-sight without any structures in the beam through one full 360 degrees turn of the vessel. Do not place the ADU close to large objects that may block the signal. To avoid obstruction elevate the ADU by mounting it on a mast or on a mounting pedestal on a deck or deck house top.

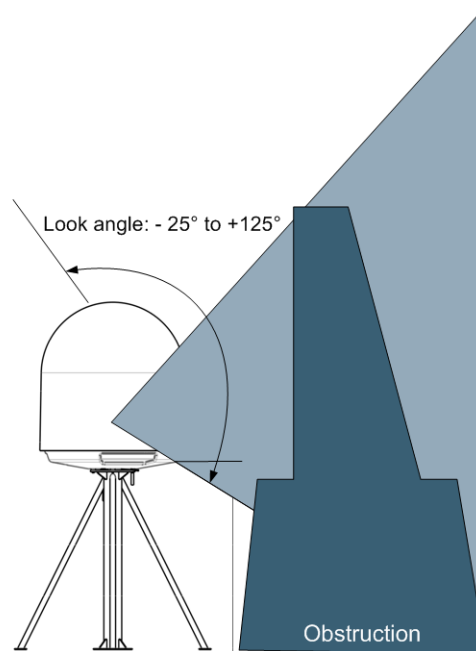

Figure 3-1: Signal degradation because of obstructing objects

The ADU is stabilized in 3-axis (plus skew) and can be used in environments with elevations of  $-25^{\circ}$  to  $+125^{\circ}$  to allow for continuous pointing even in heavy sea conditions.

The ADU beam is approximately 1 m in diameter for the first 30 m from the ADU. Beyond 30 m the beam gradually widens so that it is approximately 5 m in diameter at 100 m distance. This beam expansion continues with increasing distance.

Any obstructions, such as masts, funnels, bridge house etc. within this field can cause signal degradation or signal loss.

**Note** Please note that due to the short wavelength at Ku band and the narrow beam width of the ADU even a **6 mm steel wire placed within 50 m** inside the beam can cause signal degradation.

### 3.2.3 Blocking zones — azimuth and elevation

Your installation may require that you setup blocking zones for the ADU, i.e. areas where the ADU will not transmit and areas where transmit power is potentially dangerous for persons frequently being in these zones. You can set up 8 blocking zones. Each blocking zone is set up with azimuth start and stop, and elevation angle.

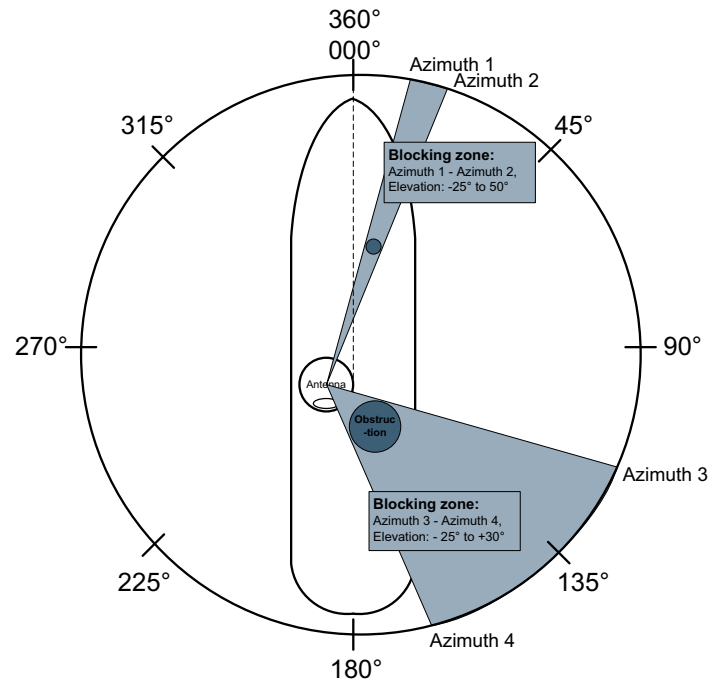

Figure 3-2: 2 blocking zones with no-transmit zones, azimuth (example)

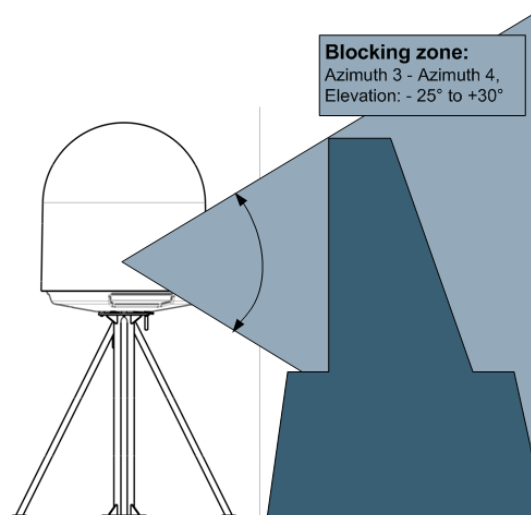

Figure 3-3: Blocking zone with no-transmit zones, elevation angle (example)

The blocking zones are set up in the SAILOR 900 VSAT built-in web interface of the ACU. For further information see *Setting up Blocking zones (RX and TX)* on page 6-24.

### 3.2.4 Safe access to the ADU: Radiation hazard

The SAILOR 900 VSAT ADU radiates up to 49 dBW EIRP. This translates to a minimum safety distance of 30 m from the ADU while it is transmitting, based on a radiation level of 10 W/m<sup>2</sup>.

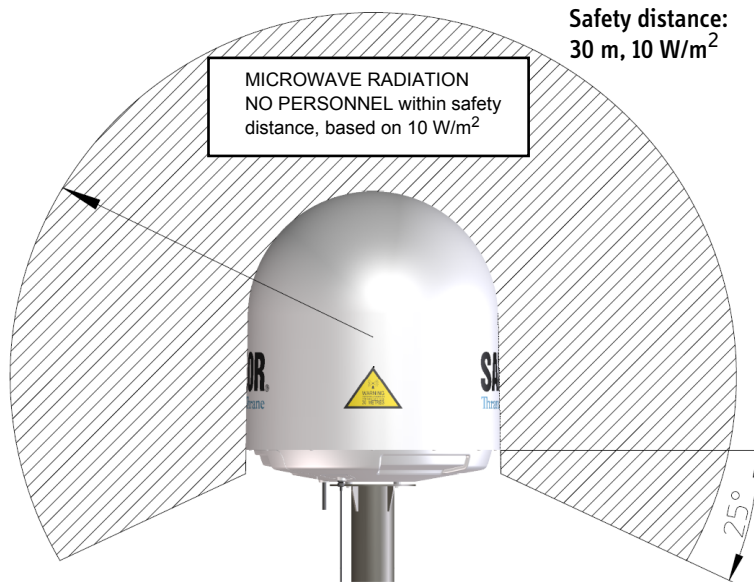

Figure 3-4: Radiation hazard, safety distance 30 m

### 3.2.5 Ship motion and offset from the ship's motion centre

Even though it is recommended to mount the ADU high, keep the distance between the ADU and the ship's motion centre as short as possible. The higher up the ADU is mounted, the higher is the linear g force applied to the ADU. The g force also depends on the roll period of the ship, see Table 3-1. If the g force applied is too high, performance and ADU signal stabilization may be reduced and eventually the ADU may be damaged. Refer to the following table for allowed mounting heights above the ship's motion centre.

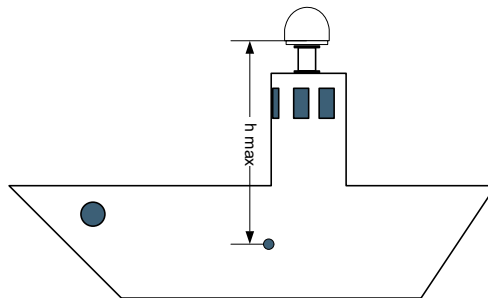

Figure 3-5: Maximum distance from the ship's motion centre (h max)

Min. roll period	Max. ADU mounting height (h max)	
	Full performance	Potential risk of damage
4 s	12 m	16 m
6 s	27 m	35 m
8 s	48 m	62 m
10 s	75 m	98 m

Table 3-1: Maximum distance from the ship's motion center versus ship's roll period

### 3.2.6 ADU mast design: Foundation and height

The ADU mast must be designed to carry the weight of the ADU unit, which is 130 kg (+ the weight of the mast flange). The mast must also be able to withstand on-board vibrations and wind speeds up to 110 knots on the radome, even in icing conditions.

#### ADU mast flange

Fit the top of the ADU mast with a flange with clearance holes matching the bushings in the radome and with minimum 4 gusset plates. No center hole is necessary in the flange.

- **Flange thickness:** Minimum 15 mm.
- **4 gusset plates:** Minimum 15 mm thick, must be placed close to the holes in the mounting plate and evenly distributed.

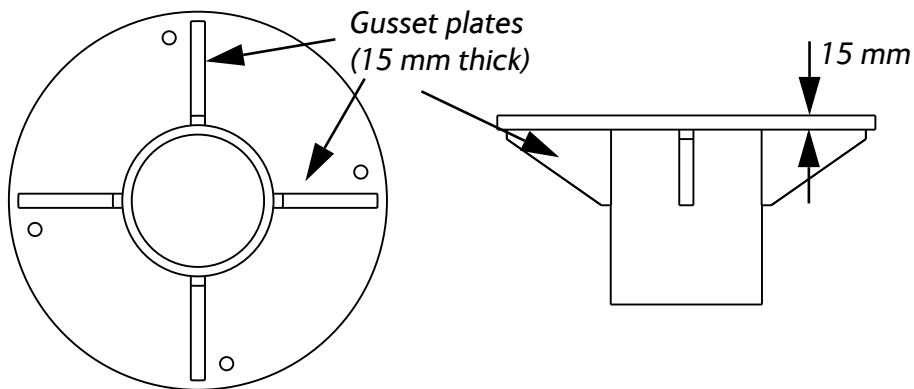

Figure 3-6: ADU mast flange, top and side view

Recommended flatness on the mast mount plateau is below 3,0 mm.

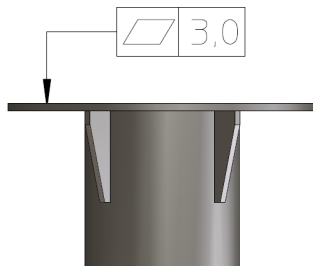

Figure 3-7: ADU mast flange, recommended flatness on the mast mount plateau



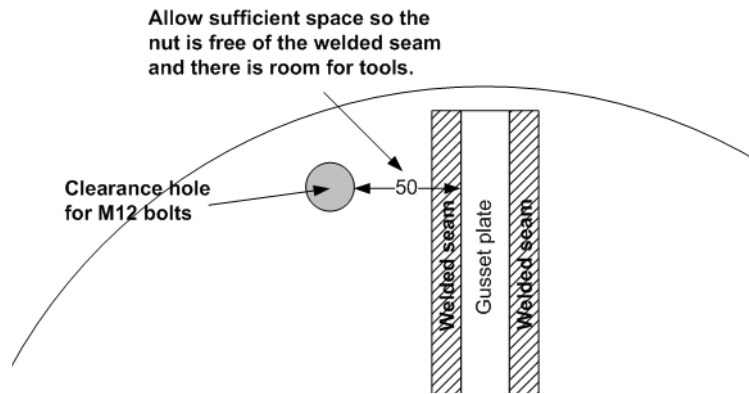

Figure 3-8: ADU mast flange, distance to the welded seam



**CAUTION!** Avoid sharp edges where the flange is in direct contact with the radome. Round all edges as much as possible to avoid damaging the surface of the radome.

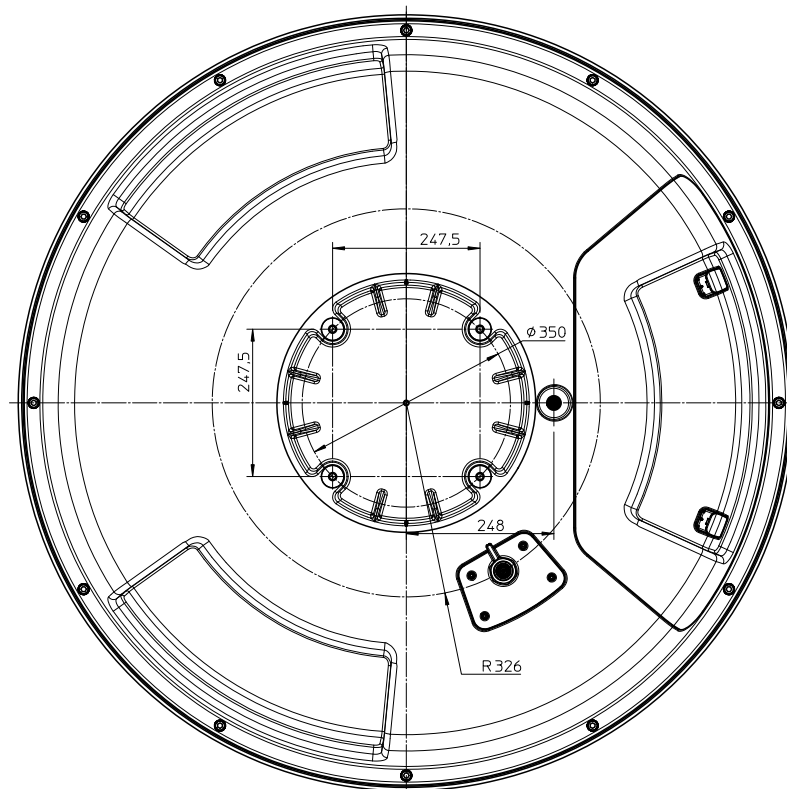

Figure 3-9: ADU, bottom view

## Mast length and diameter

The placement of the ADU must ensure a rigid structural connection to the hull or structure of the ship. Parts of the ship with heavy resonant vibrations are not suitable places for the ADU. A small platform or short mast shall provide rigid support for the ADU fastening bolts and a rigid interface to the ship.

If it is necessary to use a tall mast, you must stabilise the mast with bracing. Note that the design values given below depend on rigid ADU-ship interfaces. The cross-sectional properties and the corresponding maximum free length give a natural frequency close to 30 Hz. It is recommended to shorten the mast length as much as possible to obtain higher frequencies. Preferably, mount stays or wires to stabilize the mast further.

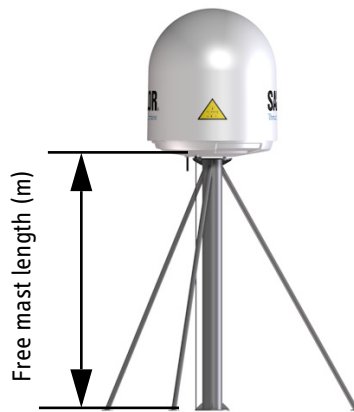

Figure 3-10: Free mast length and bracing for a tall mast

**Note** Make sure that there is free space below the drain tube. Read also *Condensation and water intrusion* on page 3-17.

The tables in the next sections give some suggested design values for the free mast length.

**Note** The tables list the values for **steel masts**. For **aluminium masts**, the free mast length is reduced to 75% of the values for steel.

**Note** Bracing and rigid masts can still not prevent vertical vibration if the mast is attached to a deck plate that is not rigid. Make every effort to mount the mast on a surface that is well supported by ribs. If this is not possible, provide extra deck plate propping.

### SAILOR 900 VSAT ADU mast length

The below tables show the minimum dimensions for a SAILOR 900 VSAT ADU mast with and without stays or wires. Note that the values are only guidelines - always consider the environment and characteristics of the ship before deciding on the mast dimensions.

Mast without braces	Max. free mast length (steel), (m)	Outer Diameter (mm)	Wall Thickness (mm)	Weight (kg/m)
	0.4 <sup>a</sup>	200	5	24.0
	0.6	220	5	26.5
	0.8	250	5	30.2
	1	270	5	32.7

Table 3-2: Mast dimensions without braces

- a. The height of 0.4 m is not recommended to be used as it will make access through the ADU's service hatch difficult.

Mast with 3 braces	Max. free mast length (steel), (m)	Outer Diameter (mm)	Wall Thickness (mm)	Outer Diameter for brace (mm)	Thickness for brace (mm)
	1.2	140	10	50	5.0
	1.2	200	5	50	5.0
	1.6	140	10	70	5.0
	1.6	200	5	70	5.0
	2	160	10	70	5.0
	2	220	5	70	5.0
	2.5	180	10	80	5.0
	2.5	220	5	80	5.0

Table 3-3: Mast dimensions with 3 braces

Mast with 2 braces	Max. free mast length (steel), (m)	Outer Diameter (mm)	Wall Thickness (mm)	Outer Diameter for brace (mm)	Thickness for brace (mm)
	1.2	160	10	80	5.0
	1.2	200	5	80	5.0
	1.6	180	10	80	5.0
	1.6	220	5	80	5.0
	2	180	10	80	5.0
	2	240	5	80	5.0
	2.5	200	10	80	5.0
	2.5	260	5	80	5.0

Table 3-4: Mast dimensions with 2 braces

### 3.2.7 Interference

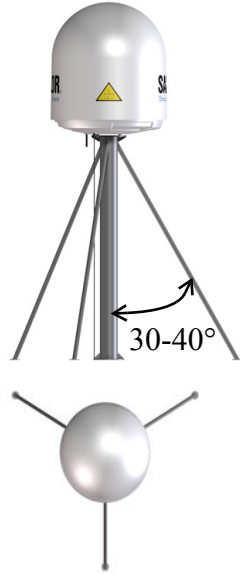
**Note** Do not place the ADU close to interfering signal sources or receivers. For allowed distances to other transmitters see Figure 3-12: *Recommended distance to transmitters (m) for frequencies below 1000 MHz* on page 3-16. We recommend testing the total system by operating all equipment simultaneously and verifying that there is no interference.

The ADU must be mounted as far away as possible from the ship's radar and high power radio transmitters, because they may compromise the ADU performance. RF emission from radars might actually damage the ADU.

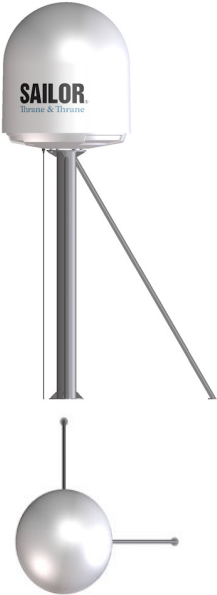
The SAILOR 900 VSAT ADU itself may also interfere with other radio systems.

#### Radar

It is difficult to give exact guidelines for the minimum distance between a radar and the ADU because radar power, radiation pattern, frequency and pulse length/shape vary from radar to radar. Further, the ADU is typically placed in the near field of the radar ADU and reflections from masts, decks and other items in the vicinity of the radar are different from ship to ship.

However, it is possible to give a few guidelines. Since a radar radiates a fan beam with a horizontal beam width of a few degrees and a vertical beam width of up to  $\pm 15^\circ$ , the worst interference can be avoided by mounting the ADU at a different level – meaning that the ADU is installed minimum  $15^\circ$  above or below the radar antenna. Due to near field effects the benefit of this vertical separation could be reduced at short distances between radar antenna and the SAILOR 900 VSAT ADU. Therefore it is recommended to ensure as much vertical separation as possible when the SAILOR 900 VSAT ADU has to be placed close to a radar antenna.

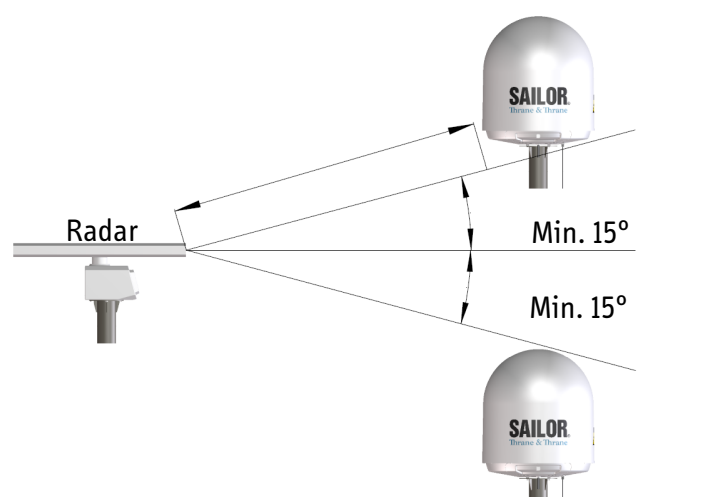

Figure 3-11: Interference with the vessel's radar

## Radar distance

The minimum acceptable separation (d min.) between a radar and the ADU is determined by the radar wavelength/frequency and the power emitted by the radar. The tables below show some “rule of thumb” minimum separation distances as a function of radar power at X and S band. If the d min. separation listed below is applied, antenna damage is normally avoided.

“d min.” is defined as the shortest distance between the radar antenna (in any position) and the surface of the SAILOR 900 VSAT ADU.

X-band (~ 3 cm / 10 GHz) damage distance		
Radar power	SAILOR 900 VSAT ADU	
	d min. at 15° vertical separation	d min. at 60° vertical separation
0 – 10 kW	1.0 m	1.0 m
30 kW	2.0 m	1.0 m
50 kW	3.3 m	1.7 m

Table 3-5: Minimum radar separation, X-band

S-band (~ 10 cm / 3 GHz) damage distance		
Radar power	SAILOR 900 VSAT ADU	
	d min. at 15° vertical separation	d min. at 60° vertical separation
0 – 10 kW	2.0 m	1.0 m
30 kW	3.0 m	1.5 m
50 kW	5.0 m	2.5 m

Table 3-6: Minimum radar separation, S-band

The separation distance for C-band (4-8 GHz) radars should generally be the same as for X-band radars.

## Radar interference

Even at distances greater than “d min.” in the previous section the radar might still be able to degrade the performance of the SAILOR 900 VSAT system.

The presence of one or more S or X-band radars within a radius up to 100 m may cause a minor degradation of the Ku-band connection. The degradation will be most significant at high radar pulse repetition rates.

As long as receiving conditions are favourable, this limited degradation is without importance. However, if receiving conditions are poor – e.g. due to objects blocking the signal path, heavy rainfall or icing, low satellite elevation and violent ship movements – the small extra degradation due to the radar(s) could cause poor connection quality.

The presence of S-band radar(s) is unlikely to cause any performance degradation – as long as the minimum distances (d min.) listed in the previous section are applied.

It is strongly recommended that interference free operation is verified experimentally before the installation is finalized.



**CAUTION!** The ADU must never be installed closer to a radar than “d min.” - even if experiments show that interference free operation can be obtained at shorter distances than “d min.” in the previous section.

## GPS receivers

Good quality GPS receivers will work properly very close to the ADU - typically down to one meter outside the main beam.

**Other transmitters**

See the following figure for minimum recommended distance to transmitters in the frequency range below 1000 MHz.

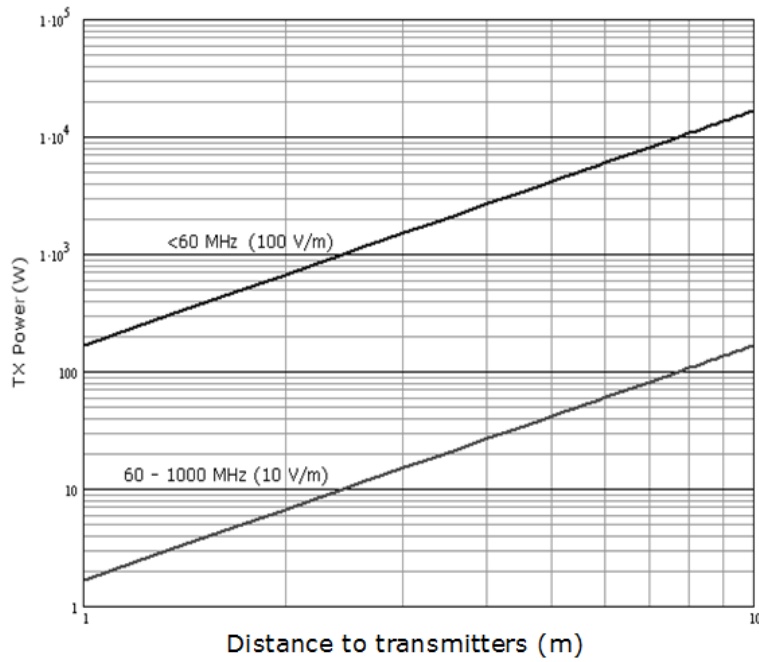

Figure 3-12: Recommended distance to transmitters (m) for frequencies below 1000 MHz



## 3.2.8 Other precautions

### Condensation and water intrusion

If possible, install the radome such that direct spray of seawater is avoided. In some weather conditions there may occur condensation inside the radome. The drain tube is designed to lead any water away from inside the radome. Make sure the ADU's drain tube is open and that there is free space between the drain tube and the mounting surface so water can escape and there is ventilation for the ADU.



Figure 3-13: Drain pipe with free space

It is recommended not to use pneumatic tools for cleaning the radome, especially at a short distance and directly at the split between top and bottom.

### Deposits

Do not place the ADU close to a funnel, as smoke deposits are corrosive. Furthermore, deposits on the radome can degrade performance.

### 3.3 Installation of the ADU

The ADU is shipped fully assembled. You have to install it on the mast and attach the ADU cable.



**WARNING!** Use a strong webbed sling with a belt to lift the ADU without damaging the radome. Make sure that the sling can carry the ADU's weight (130 kg, 287 lbs).



**WARNING!** The ADU may be subject to swaying motions in windy conditions. Always use tag lines to stabilise the ADU during hoisting.

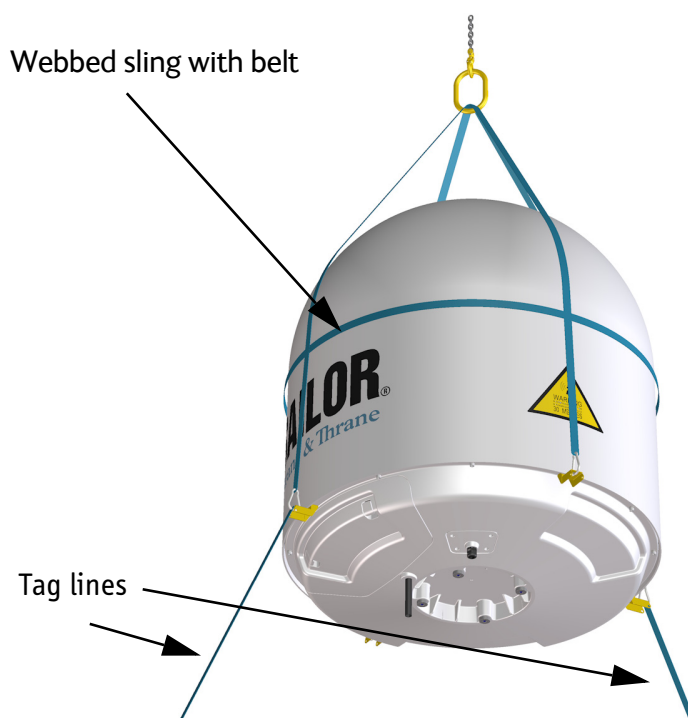

Figure 3-14: Use of strong sling with a belt and tag lines for safe hoisting

Before installing the ADU read the following guidelines.

### 3.3.1 Installing the ADU

Make sure that there is sufficient space underneath the ADU to open the service hatch. Through this hatch you access the ADU modules for service and maintenance.



Figure 3-15: Free space for access to the service hatch

The ADU does not have to be aligned with the bow-to-stern line of the ship. When configuring the SAILOR 900 VSAT you make an azimuth calibration to obtain the correct azimuth of the ADU.

- It is important to maintain **vertical orientation of the ADU center line**.
- Consider the aspect of interference, read more about this in *ADU mast design: Foundation and height* on page 3-8.
- Install the ADU where **vibrations are limited to a minimum**.
- Always use **all 4 bolts** when installing the ADU.

To install the ADU, do as follows:

1. Install the mast with the mast flange and have the 4 M12 bolts ready.
2. Undo all shipping buckles, take off the wooden top and remove the casing.
3. Unscrew the 4 bolts holding the ADU on the wooden platform.

4. Attach a webbed, four-part sling with a belt to all 4 lifting brackets.



Figure 3-16: ADU installation, webbed sling attached to the 4 lifting brackets

5. Attach 2 tag lines of suitable length to 2 lifting brackets and man them.
6. With a crane lift the ADU off the wooden platform and move it on top of the ADU mast.
7. Install the ADU on the mast flange with 4 M12 bolts and washers. Read carefully and follow instructions given in *Grounding the ADU* on page F-2.  
Tightening torque value: 30 Nm



Figure 3-17: Mounting the ADU on the mast flange

8. Put the coaxial ADU cable through the protection plate as shown in the following figure, and connect the N connector of the ADU cable to the ADU.

Select a suitable size for the cable gland: 16—20 mm diameter or 19—23 mm diameter. See also *N-connector interface on the ADU* on page A-8 for a more detailed drawing how to connect the N-connector on the ADU.

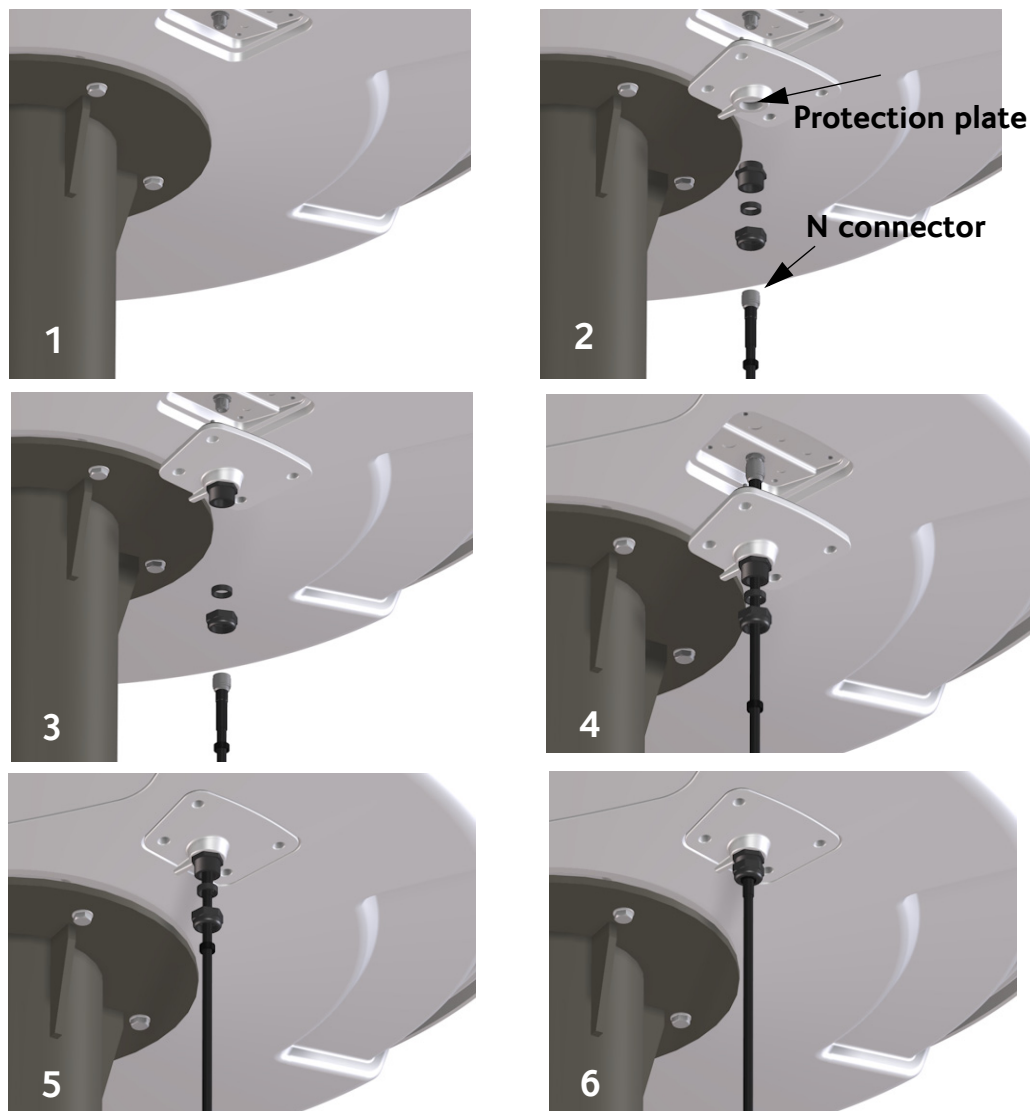

Figure 3-18: Connecting the ADU cable

Ensure that the connector assembly is properly protected against seawater and corrosion. As a minimum, wrap it with self-amalgamating rubber.

9. Put the protection plate in place and fasten the 4 bolts (picture 5).
10. Fasten the nut (picture 6).

Where the cables are exposed to mechanical wear — on deck, through bulkheads, etc. — protect the cables with steel pipes. Otherwise, follow standard procedures for cabling in ship installations.

### Maximum allowed RF loss in the ADU cable

Maximum allowed cable loss  $\leq 20$  dB at 1950 MHz. This is to ensure optimum performance of the system.

### 3.3.2 Opening and removing the service hatch

Open the hatch to access the antenna modules. The two latches of the service hatch must be locked by fastening the two screws in the latches with a Torx TX20 screw driver to protect the ADU modules against unauthorised access.

You can remove the hatch for better mobility when servicing the antenna. Do as follows to open and remove the service hatch:

1. With a Torx TX20 screw driver, remove the two screws locking the latches.
2. Pull open the two latches and let the lid fall open.



Figure 3-19: Opening the service hatch

3. Remove the 2 split pins and park them.



Figure 3-20: Removing the 2 split pins

4. Pull the service hatch free.

### 3.3.3 Grounding the ADU

The ADU must be grounded using the mounting bolts. If the ADU cannot or should not be electrically connected directly to the mounting surface, you can use a separate grounding cable to make the connection between the ADU and the common ground to which the ACU is also connected. If grounding to the ship ground is impossible, for example if you have a fibre glass hull, see *Alternative grounding for fibre glass hulls* on page F-6.

To obtain a good ground connection, the metal underneath the head of **at least** one bolt must be clean of insulating protective coating and a serrated washer should be used. After tightening the bolts we recommend that you seal the area suitably in order to avoid corrosion of the grounding point. Use stainless steel bolts and washers.

Optimum grounding is achieved by connecting the ground wire to the bolt marked in Figure 3-21.

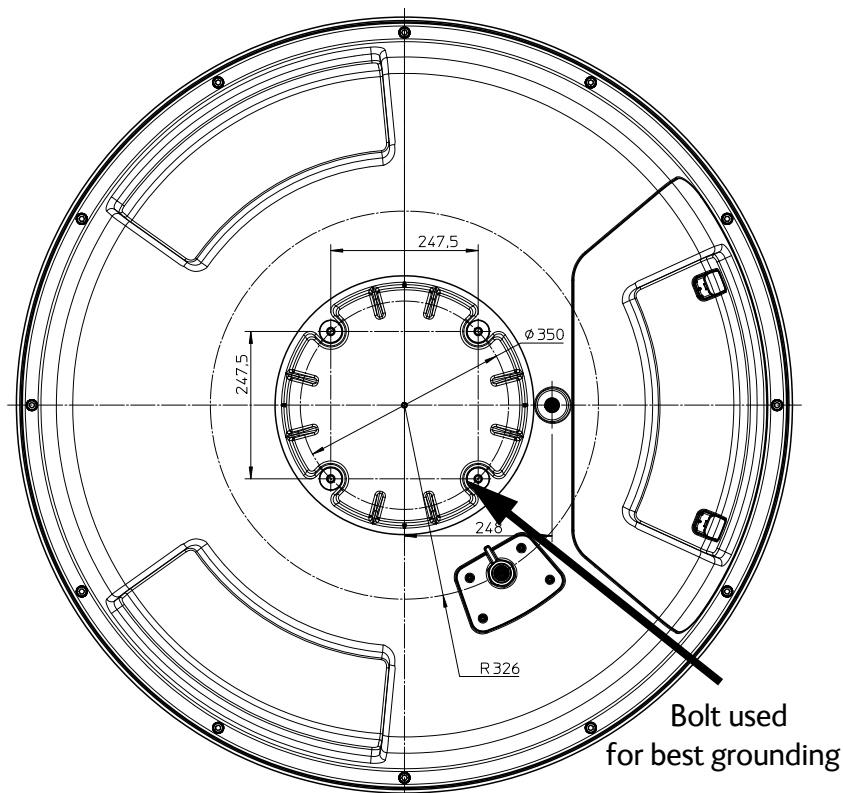

Figure 3-21: ADU, bolt for optimum grounding

For further information on grounding and RF protection see *Grounding and RF protection* on page F-1.

### 3.3.4 Alternative ADU cable

The maximum allowed RF-loss in the ADU cable must be  $\leq 20$  dB at 1950 MHz and 0.9 Ohm DC. This is to ensure the performance of the system. Preferably choose one of the cable types listed in the table below.

Cable Type	Absolute maximum length
G02232-D	6 m
RG223-D	25 m
RG214/U	50 m
S 07272B-05	95 m

Table 3-7: ADU cable types and maximum lengths

Check the data sheet from the cable supplier that both the RF-attenuation and the DC-resistance are kept within the maximum specified values:

- ADU cable RF-attenuation at 1950 MHz: max. 20 dB including connector.
- ADU cable modem-attenuation at 10 MHz: Max. 2 dB  
ADU cable modem-attenuation at 36 and 54 MHz: Max. 4 dB
- ADU cable loop DC-resistance max: 0.9 Ohm.

Also ensure that the specified minimum bending radius is respected. If this is not the case, the loss in the cable will increase. Check the documentation from the cable supplier.



## 3.4 Installation of the ACU

The following sections describe the installation of the ACU.

### 3.4.1 Installing the 19" rack version of the ACU

A cable relief bracket is already mounted when receiving the ACU. The cable relief is a simple system to secure cables with cable strips. It offers a number of holders to which you can secure the cables from the ACU. To install the 19" rack version of the ACU, do as follows:

1. Slide the ACU into a 1U space in a 19" rack.
2. Mount the screws in each side through the holes in the front and fasten the screws to the rack. Make sure that the unit is mounted securely according to the requirements for your 19" rack.
3. Connect all cables. See *Interfaces of the SAILOR 900 VSAT ACU* on page 4-1 for a description of the ACU connectors.



Figure 3-22: ACU, 19" rack version, On/off switch at the back

4. Set the On/Off switch at the back of the ACU to On. Then you can use the On/Off switch at the front panel of the ACU 19" rack version.

For a description of the connectors see *ACU connector panel — overview* on page 4-1. The ACU has additionally a LAN connector at the front for accessing the service port from the ACU front panel.



Figure 3-23: ACU, LAN connector at the front: Service port

For information on wiring 24 VDC power see *DC Input connector* on page 4-2. For information about power supply and power requirements see *Connecting power* on page 5-1.

### 3.4.2 Grounding the ACU

Make sure that the grounding requirements are met. See the appendix *Grounding and RF protection* on page F-1 for details about grounding.

## ADU cable

The ADU is connected to the ACU with the ADU cable (coax cable) with an N connector at both ends. For information on ADU grounding, see *Grounding the ADU* on page 3-23.

At the ACU end, it is strongly recommended to ground the ADU cable. Use a short cable from the ACU to a grounding point in the rack and connect the short cable to the ADU cable at this grounding point, making sure the shield of the connector is properly connected to the rack.

## Ground stud at the ACU

To ensure that the ACU is grounded – also if the ADU cable is disconnected from the ACU, connect an extra ground wire from the rack to the ground stud on the ACU. This ground wire must be a heavy wire or braid cable with a larger diameter than the coax cable.



Figure 3-24: ACU, 19" rack version, ground stud

## 3.5 Installation of the VMU

For a list of supported VSAT modems see the SAILOR 900 VSAT data sheet or Figure 6-16: *Web interface: SETTINGS, VSAT modem profile – supported modems*.

### 3.5.1 General mounting considerations — VMU

1. Mount the VMU close to the ACU, preferably at a distance less than 1 m.
2. Connect all cables. See *Interfaces of the VMU* on page 4-7 for a description of the connectors for supported VSAT modems.  
For cable specifications see *VMU cables* on page B-1.

### Connectors and pin-out of the VMU

For connectors and pin-out see the user documentation of the VMU and *Interfaces of the VMU* on page 4-7.

### Wiring Power

Provide power to the VMU as described in the user documentation of the unit.

## 3.6 Installing the dual-antenna mode (optional)

You can use the SAILOR 900 VSAT in dual antenna mode with 2 ADUs, 2 ACUs and the dual-antenna accessories kit. The kit consists of 2 75 Ohm RF cables, an RF splitter and an RF combiner. In case one antenna enters a blocking zone, the other antenna of the dual-antenna system takes over and the system continues working.

There is a Master ACU and a Slave ACU. The VSAT modem is connected to and configured in the Master ACU. The Slave ACU is configured as a slave unit. It is connected with an Ethernet cable to the Master ACU from which it gets all satellite information.

The switching from one antenna to the other is done based on the programmed blocking zones in the two antennas and takes effect whenever signal blockages occur from cranes etc.

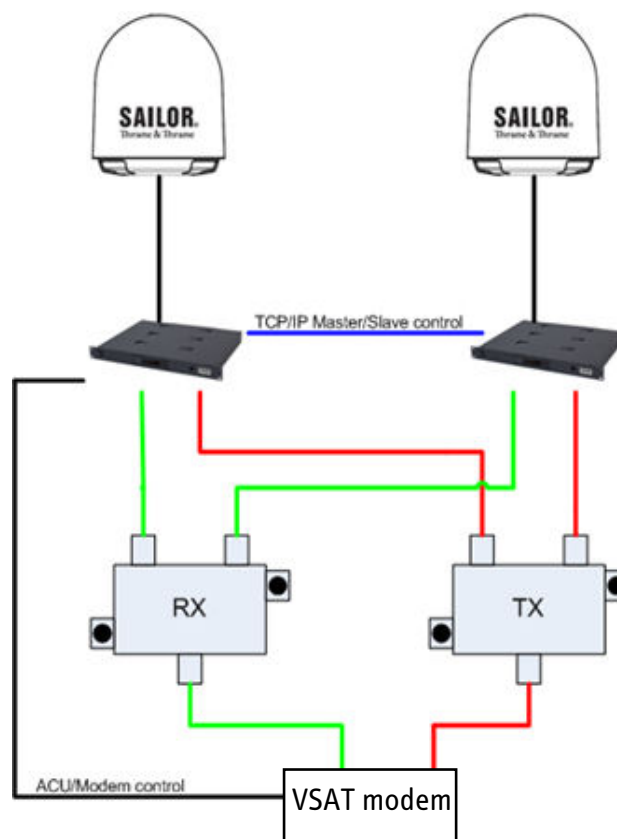

Figure 3-25: Dual mode antenna, overview

To install the dual antennas, do as follows:

1. Install the master ADU, ACU, the RX combiner and the VSAT modem as shown in figure 3-25.
2. Install the slave ADU, ACU, the TX splitter as shown below.

3. Connect the cables as shown below and in the table below.

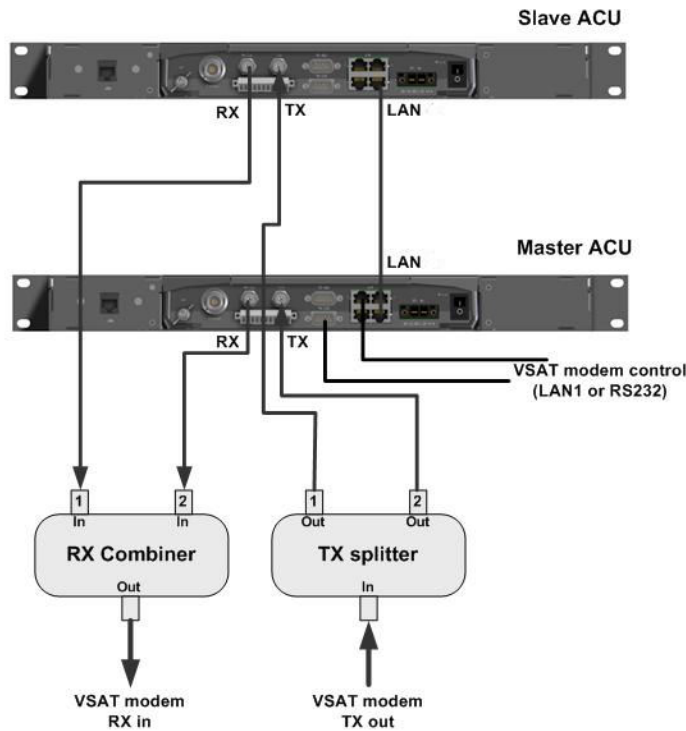

Figure 3-26: Dual mode antenna, connecting cables (example)

Connect cables	Purpose
Master ACU LAN to Slave ACU LAN	Master/Slave control
Master ACU LAN port 1 or RS 232 to VSAT modem control	VSAT modem control
Master ACU Rx Out to the Rx combiner input 1	Rx when Master active
Slave ACU Rx Out to the Rx combiner input 2	Rx when Slave active
Rx combiner output to VSAT modem Rx	Rx to VSAT modem
Master ACU Tx In to the Tx splitter output 1	Enabled when Master active
Slave ACU Tx In to the Tx splitter output 2	Enabled when Slave active
Tx splitter input to VSAT modem Tx	Tx from VSAT modem

Table 3-8: Dual mode antenna, cabling

# Interfaces

This chapter is organised in the following sections:

- *Interfaces of the SAILOR 900 VSAT ACU*
- *Interfaces of the VMU*

## 4.1 Interfaces of the SAILOR 900 VSAT ACU

### 4.1.1 LEDs, display and keypad



Figure 4-1: ACU — LEDs, display and keypad



Figure 4-2: ACU: LEDs, display and keypad (detailed)

### 4.1.2 ACU connector panel — overview

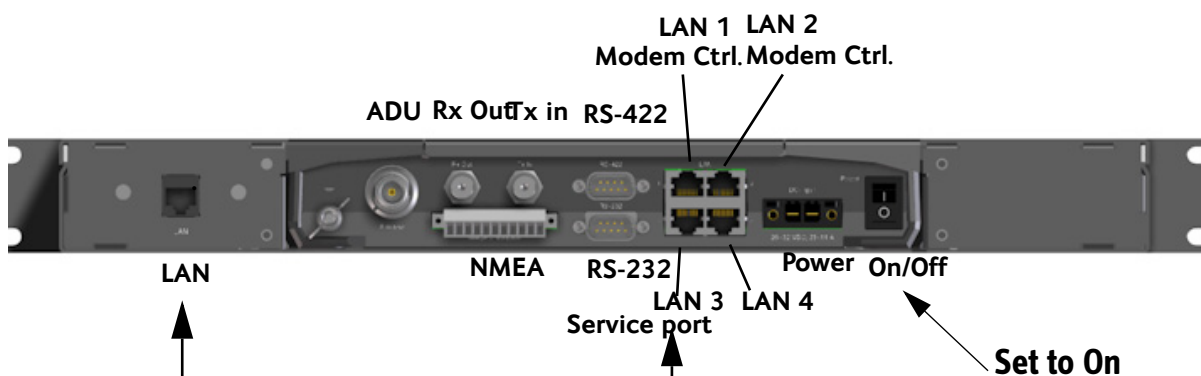

Figure 4-3: ACU rack version, connector panel overview

The connector LAN on the front panel is typically connected to the service port at LAN3 with a straight Ethernet cable. Then you can access the service port from the front of the ACU rack version.

**Important** Set the On/Off switch at the back of the ACU to On. Then you can use the On/Off switch at the front panel of the ACU 19" rack version.

Connect the Ethernet cable to provide connection to the service port on the front of the ACU 19" rack version.

### 4.1.3 DC Input connector

Provide DC power to the ACU, for example by using the TT-6080A Power Supply or 24 VDC from the vessel's power supply.

**DC input:** Female plug (Weidmuller, Part number 1930050000) for wires up to AWG10/6 mm<sup>2</sup>.

Outline (on the ACU)	Pin	Pin function	Wire color
 $V_{in}^+$ $V_{in}^-$	Left	Vin+	Red
	Right	Vin-	Black

Table 4-1: DC Input plug, outline and pin assignment

The connector for DC input is included in the delivery. Insert the power cable as shown below, and plug in the connector. Use the two red clamps to fasten the connector.

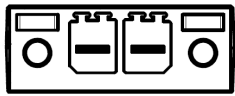
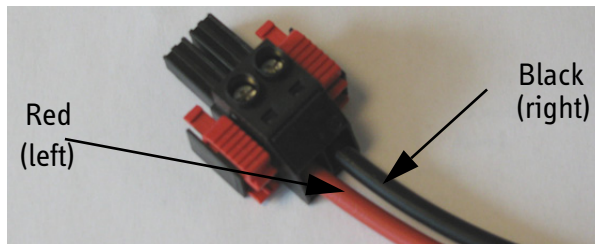

Figure 4-4: DC Input connector with power cable

For more information about power supply and power requirements see *Connecting power* on page 5-1.

### 4.1.4 ADU connector

There is just one cable from the ACU to the ADU. This is used to power the ADU, supply 10 MHz clock, handle all communication between ACU and ADU, and deliver the VSAT Rx and Tx signals.

Outline (on the ACU)	Conductor	Pin function
	Inner	DC to ADU 10 MHz clock to ADU ACU to ADU internal communication VSAT Rx/Tx
	Outer	GND (Shield)

Table 4-2: N connector, outline and pin assignment

**Important**

Do not use TNC connectors on the ADU antenna cable or on pigtails. TNC connectors cannot carry the DC current for operating the ADU.

### 4.1.5 Rx/Tx connectors for VMU

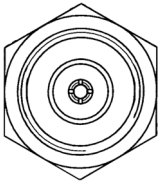
Connect the Rx and Tx channels of the VMU to the Rx and Tx connectors of the ACU with the 2 supplied Rx/Tx cables (75 Ohm coax, F-F, 1 m).

Outline (on the ACU)	Pin number	Pin function
	1	Inner conductor: 10 MHz clock, VSAT Rx/Tx
	2	Outer conductor: GND (Shield)

Table 4-3: F connector, Rx and Tx, outline and pin assignment

For step-by-step guidelines how to set up the VSAT modem see *VMU settings* on page C-1.

### 4.1.6 NMEA 0183 connector (RS-422)

Connect the ship's gyro to this connector.

Outline (on the ACU)	Pin number	Pin function	Wire color
	1	Not connected	—
	2	NET-H (NMEA 2000)	White
	3	NET-L (NMEA 2000)	Blue
	4	NET-S (NMEA 2000)	Red
	5	NET-C (NMEA 2000)	Black
	6	Not connected	—
	7	Not connected	—
	8	Shields. Ship ground. Connect only at one end.	
	9	Line B (+) NMEA 0183	
	10	Line A (-) NMEA 0183	
	11	Not connected	—

Table 4-4: NMEA 0183/2000 connector, outline and pin assignment

(Hardware prepared for NMEA 2000, for future use)

NMEA 2000 power: 9-16 VDC. NMEA 2000 LEN (Load Equivalency Number): 2 (100mA)

### NMEA 0183

The NMEA 0183 connection supports IEC 61162-1 and IEC 61162-2.

- IEC 61162-1, baud rate 4800, format 8N1.
- IEC 61162-2, baud rate 38400, format 8N1.

The baud rate is auto detected by the ACU, the user cannot configure this interface.

#### Supported NMEA string:

1. HEHDT (North seeking Gyro compass)
2. GPHDT (GPS compass)
3. HNHDT (Non-North seeking gyro compass)
4. IIHDT (Integrated Instrument)
5. HCHDT (Magnetic compass)



**Recommended NMEA 0183 cable:**

Two-wire constructed with one enclosed shield

Network signal pair:

- Size: No. 24 AWG (0.24 sq. mm) or heavier
- Characteristic impedance: 95 - 140 Ohm
- Propagation delay: 5 nanoseconds per meter, maximum
- 15 Twists (minimum) per meter

**4.1.7 RS-232 and RS-422 connectors**

These connectors are used to access and configure the connected VSAT modem and for ACU control. See the VSAT modem requirements for use of the RS-232 or RS-422 connector.

Outline (on the ACU)	Pin number	Pin function
	1	Not connected
	2	RXD
	3	TXD
	4	DTR
	5	Ground
	6	DSR
	7	RTS
	8	CTS
	9	Receive Signal Strength Indicator

Table 4-5: RS-232 connector, male, outline and pin assignment

Outline (on the ACU)	Pin number	Pin function
	1	Ground
	2	Line A RXD (+)
	3	Line B TXD (-)
	4	Ground
	5	Ground
	6	Not connected
	7	Line A RXD (-)
	8	Line B TXD (+)
	9	Not connected

Table 4-6: RS-422 connector, male, outline and pin assignment

### 4.1.8 LAN1, LAN2, LAN3 and LAN4 connectors

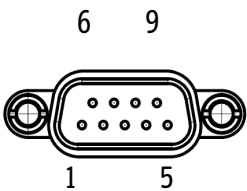
Four Ethernet connectors (type RJ45) for PC/lap tops, routers, wireless access points. The maximum cable length per connection is 100 m. Depending on the VMU connected, a LAN connector may be used for modem control.

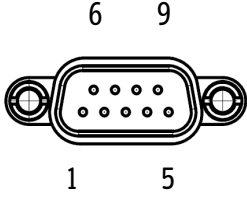
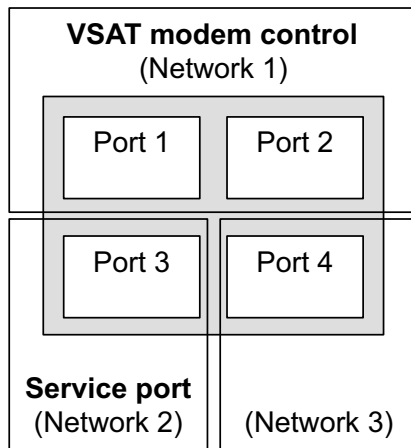

Figure 4-5: LAN1 —LAN4 connectors

For information how to configure the LAN network see *Configuring the LAN network* on page 6-26.

Outline	Pin number	Pin function	Wire color
	1	Tx+	White/orange
	2	Tx-	Orange
	3	Rx+	White/green
	4	Not connected	Blue
	5	Not connected	White/blue
	6	Rx-	Green
	7	Not connected	White/brown
	8	Not connected	Brown

Table 4-7: Ethernet connector, outline and pin assignment

Cable type: CAT5, shielded.

## 4.2 Interfaces of the VMU

For interfaces of the VMU and how to connect a VMU correctly to the ACU see the following sections and the user documentation of the VMU.

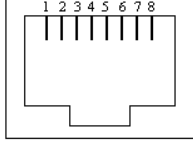
For step-by-step guidelines how to set up the VSAT modem see Appendix C, *VMU settings*.

### 4.2.1 Connecting an iNFINITI® Series Satellite Router

Connect the VSAT modem to the ACU as shown in the figure below:

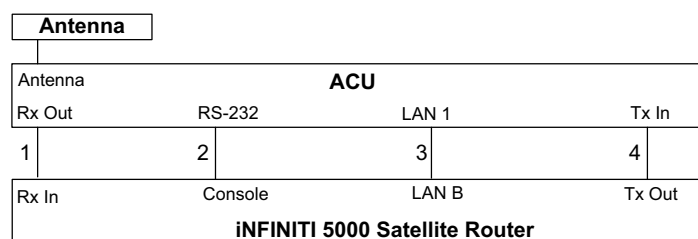

Figure 4-6: Connecting an iNFINITI® Series Satellite Router

**Note** | Cable 3 is only used when using OpenAMIP protocol.

Cable	Description	Cable specifications
1	RX Out to Rx In	75 Ohm coax cables F-F (1 m), included
2	RS-232 to Console	
3	LAN 1 or 2	Standard Ethernet cable
4	Tx In to Tx out	75 Ohm coax cables F-F (1 m), included

Table 4-8: Cables to connect an iNFINITI® Series Satellite Router

For a detailed cable specification for VSAT modems see *VMU cables* on page B-1. For step-by-step guidelines how to set up the VSAT modem see Appendix C, *VMU settings*.

### 4.2.2 Connecting an Evolution® Satellite Router

Connect the VSAT modem to the ACU as shown in the figure below:

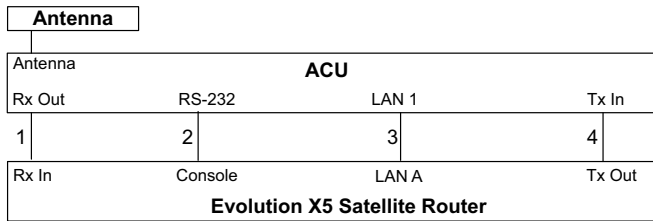

Figure 4-7: Connecting an Evolution Satellite Router

**Note** Cable 3 is only used when using OpenAMIP protocol.

For cables see Table 4-8: *Cables to connect an iNFINITI® Series Satellite Router* on page 4-8. For VMU cable specifications see *VMU cables* on page B-1.

### 4.2.3 Connecting a COMTECH 570 L or 625 Satellite Modem

Connect the VSAT modem to the ACU as shown in the figure below:

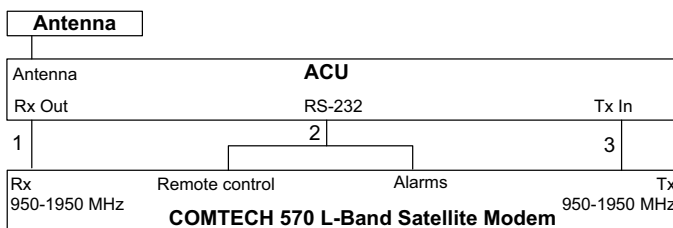

Figure 4-8: Connecting a COMTECH 570 L or 625 Satellite Modem

**Note**

If the satellite profile is configured to use **narrow band tracking** (recommended) a standard RS-232 cable can be used to connect the ACU RS-232 port to the Remote control port of the VSAT modem.

If the satellite profile is configured to use modem **RSSI tracking** a proprietary RS-232/Alarm cable must be used to connect the ACU RS-232 port to the Remote control and Alarm port of the VSAT modem.

Cable	Description	Cable specifications
1	RX Out to Rx 950-1950 MHz	75 Ohm coax cables F-F (1m) and adapter F to N 50 Ohm, included
2	RS-232 to Remote control and Alarms	37-134337-A Cable COMTECH Serial and RSSI
3	Tx In to Tx 950-1950 MHz	75 Ohm coax cables F-F (1 m), included

Table 4-9: Cables to connect a COMTECH 570 L-Band Satellite Modem

For VMU cable specifications see *VMU cables* on page B-1.

### 4.2.4 Connecting a Satlink 2900 VSAT modem

Connect the VSAT modem to the ACU as shown in the figure below:

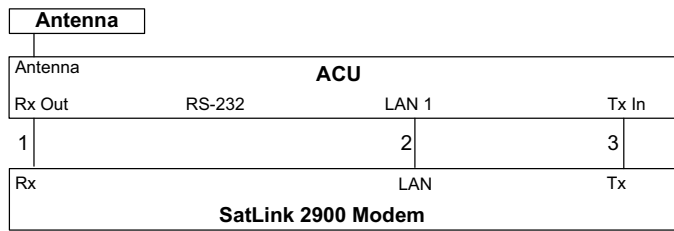

Figure 4-9: Connecting a SatLink 2900 Modem

Cable	Description	Cable specifications
1	RX Out to Rx	75 Ohm coax cables F-F (1m) and adapter F to N 50 Ohm, included
2	LAN1 to LAN	Standard Ethernet cable
3	Tx In to Tx	75 Ohm coax cables F-F (1 m), included

Table 4-10: Cables to connect a SatLink 2900 VSAT modem

### 4.2.5 Connecting a Gilat SkyEdge II VSAT modem

Connect the VSAT modem to the ACU as shown in the figure below:

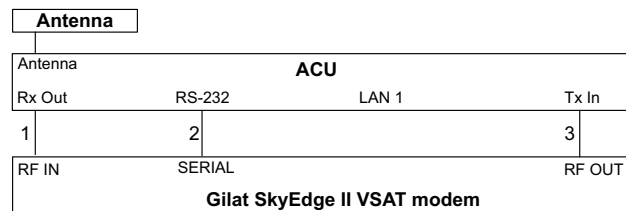

Figure 4-10: Connecting a Gilat SkyEdge II VSAT Modem

Cable	Description	Cable specifications
1	RX Out to RF IN	75 Ohm coax cables F-F (1m) and adapter F to N 50 Ohm, included
2	RS-232 to SERIAL	
3	Tx In to RF OUT	75 Ohm coax cables F-F (1 m), included

Table 4-11: Cables to connect a Gilat SkyEdge VSAT modem

# Connecting power

This chapter is organised in the following sections:

- *Power source*
- *Power cable selection*
- *Connecting power*
- *Power up*

## 5.1 Power source

There are different options for the power supply:

- The 24 VDC ship supply provides power for the ACU.
- An AC line provides power through an AC/DC power supply. The TT-6080A Power Supply is recommended.

**Note** | Be aware of high start-up peak current: 35 A at 24 VDC, 5 ms.

In order to protect against short circuit in the power cable/connector, the ship's DC outlet must be protected by a 30 A fuse or circuit breaker.

## 5.2 Power cable selection

### 5.2.1 Source impedance

The maximum length of the power cable depends on the type of cable used and the source impedance of the DC power installation in the ship.

The maximum allowed source impedance depends on the usage of the power range of the terminal DC input (Start up voltage: 22 VDC guaranteed, operating range: 20 — 32 VDC; 23 A - 14 A).

Select a power outlet from the DC system and measure the source impedance of the ship installation as described in the next section.

#### Note

If the total impedance is higher than the limits stated in section 5.2.3, the terminal may become unstable and start to on/off oscillate.

The total impedance is made up of the source impedance of the ship power supply plus the impedance of connected cables including connectors and joints where cables are extended.

For further recommendations on power cable selection, see *Power cable recommendations* on page 5-3.

### 5.2.2 Measuring the ship source impedance

Select a power outlet from the ship 24 VDC system and measure the source impedance of the ship installation as described below.

1. Measure the voltage without load (R.var disconnected).
2. Set the current to e.g. 1 A by adjusting R.var.
3. Measure the corresponding voltage change.

**Example:** 1 A and 50 mV. Source impedance:  $50 \text{ mV}/1 \text{ Amp} = 50 \text{ mOhm}$ .

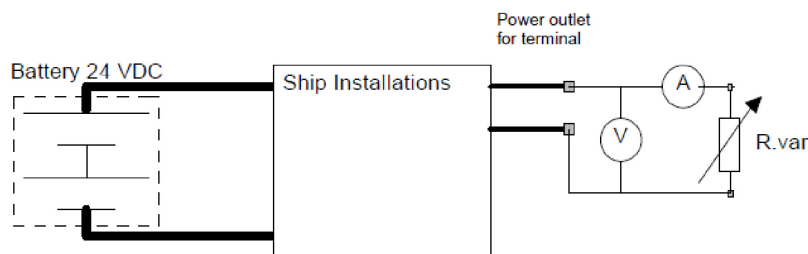

Figure 5-1: Measuring the ship source impedance



## 5.2.3 Power cable recommendations

### Overview

The ACU is delivered with a power connector (PCB plug-in connector, female plug, Weidmuller, Part number 1930050000), which accepts wires up to AWG10/6 mm<sup>2</sup>.

- When installing the power cable, install positive and negative supply wires closely together side by side to keep cable inductance low.
- Ensure that cable inductance for the selected cable at the desired length is less than 50 uH. Approximately 50 m maximum length.

### Calculating the maximum power cable length

For 24 VDC operation, the total impedance must be max. 60 mOhm ( $R_{max}$ ), including the source impedance in the ship installation ( $R_{source}$ ).

The total impedance is made up of the following:

- Source impedance in the ship installation
- Impedance of the selected power cable

To calculate the maximum cable extension, do as follows:

1. First measure the source impedance in the ship installation as shown in *Measuring the ship source impedance* on page 5-2.
2. Find the resistance per meter ( $R_{wire}$ ) for the cable type you are going to use.  
For 4 mm<sup>2</sup>/AWG 11, the value is 4.8 mOhm/m at 55°C  
For 6 mm<sup>2</sup>/AWG 10, the value is 3.8 mOhm/m at 55°C  
For other cable types, refer to the data sheet for the cable.

$$\text{Maximum length} = 0,5 \times (R_{max} - R_{source}) / (R_{wire})$$

The length is multiplied by 0.5 above because there are two conductors in the cable.  
If the TT-6080A Power Supply is used, use  $R_{source} = 0$  mOhm.

### Examples for using the TT-6080A Power Supply:

$$\text{AWG11}_{max} = 0.5 \times (60 \text{ mOhm} - 0) / 4.8 \text{ mOhm/m} = 6.2 \text{ m}$$

$$\text{AWG10}_{max} = 0.5 \times (60 \text{ mOhm} - 0) / 3.8 \text{ mOhm/m} = 7.9 \text{ m}$$

## 5.3 Connecting power

### To connect the power cable to the ACU

1. Connect the positive and negative input terminals to the ship's DC supply according to the recommendations in the previous sections.
2. Connect the power plug to DC Input.

For information on pin-out, see *DC Input connector* on page 4-2.



Figure 5-2: Connecting power to DC Input

## 5.4 Power up

1. Connect power to the VMU.
2. Switch on the ACU. The unit starts up and goes through an initialization procedure:
  - ACU POST
  - ADU Initializing
  - ADU POST
  - READY

This may take some time (up to a couple of minutes).

3. The SAILOR 900 VSAT is ready to be calibrated (for first time power up) or receive data from the VSAT modem (when in normal operation). The ACU display shows the following message:



Figure 5-3: ACU display after first power on (example with LAN ports 1 and 4 used)

The LEDs **Power** and **Fail/Pass** are **steady green**, the LED Logon is off. For further information on status indicators see *Status signalling with LEDs and status messages* on page 8-8.

Make sure there are no hardware failures or error codes present, check the display of the ACU for events. For more information on error codes and events see *Troubleshooting* on page 8-14 and *System messages* on page G-1.

4. Continue to get the SAILOR 900 VSAT system operational, do the following:
  - Make a cable loss and an azimuth calibration.
  - Create VSAT modem profiles.
  - Create one or more satellite profiles.

For step-by-step instructions, see *Introduction to the built-in web interface* on page 6-1.

For installation check lists see, *Installation check* on page 7-1.

## Initialisation in daily use

Once the system is configured and a satellite profile is active, the startup sequence is as follows:

- ACU POST
- ADU Initializing
- ADU SW upload (If the software versions in the ADU and ACU are not the same, a software update is done during startup.)
- ADU POST
- READY
- POINTING ANTENNA
- ACQUIRING SIGNAL
- TRACKING

## SAILOR 900 VSAT operational

When the display shows **TRACKING** and the LED **Logon** is steady green, the system is operational.

# Configuration

This chapter is organised in the following sections:

- *Introduction to the built-in web interface*
- *Calibration of the SAILOR 900 VSAT*
- *Configuration with the web interface*
- *Keypad and menus of the ACU*
- *SNMP support*

## 6.1 Introduction to the built-in web interface

### 6.1.1 Overview

Use the built-in web interface of the SAILOR 900 VSAT ACU to make a full configuration of the SAILOR 900 VSAT with the correct VMU, the satellite positions you intend to use and other parameters.

Connect the LAN cable to LAN 3 on the rear panel or the front LAN connector of the ACU.

**For quick start instructions see *Calibration of the SAILOR 900 VSAT* on page 6-3.**

No installation of software is necessary. The web interface is built into the SAILOR 900 VSAT ACU. You access the web interface from a computer with a standard Internet browser.

### 6.1.2 Connecting to the web interface

To connect to the web interface of the ACU do as follows:

1. Power up the SAILOR 900 VSAT system, i.e. switch on the ACU. Wait until the LEDs on the front plate of the ACU show that the system is ready to be configured.
  - Power LED: Green
  - Logon LED: Off
  - Fail/Pass LED: Flashing green, during power-on self test, after that steady green.
2. Connect a PC to LAN interface 3 (Service port, standard Ethernet) of the ACU or to the front LAN connector of the ACU.

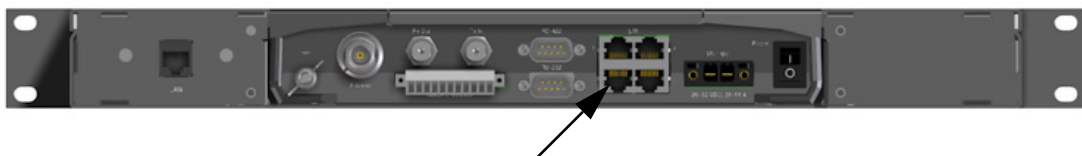

Figure 6-1: LAN connector used for configuring the SAILOR 900 VSAT

3. Open your Internet browser and enter the IP address of the ACU. The IP address is **http://192.168.0.1** (default).
4. The web interface shows the **DASHBOARD** page.

The screenshot displays the Thrane & Thrane SAILOR 900 VSAT Dashboard. At the top, there is a header with the company name and a signal strength indicator. Below this is a navigation menu with options: DASHBOARD, SETTINGS, SERVICE, ADMINISTRATION, HELPDESK, and SITE MAP. The main content area is divided into several sections:

- SAILOR 900 VSAT**: This section contains a table of system parameters.
 

System status	Tracking	ACU part name	TT-7016A
GPS position	55°48' N, 12°31' E	ADU part name	TT-7009A
Vessel heading	0°	ACU serial number	ACU_4
Satellite profile	ROSS	ADU serial number	12345678
Satellite position	37.5°W	Software version	1.41 build 7
RX polarisation	Horizontal	<b>POINTING</b>	
TX polarisation	X-pol	Azimuth relative	234.4°
RX RF frequency	11.520900 GHz	Elevation relative	12.4°
LNB LO frequency	9.750000 GHz	Polarisation skew	28.0°
TX RF frequency	14.116940 GHz	<b>TX</b>	
BUC LO frequency	12.800000 GHz	BUC TX	On
Tracking RF frequency	11.520900 GHz	BUC output power	■■■■
- VSAT MODEM**: This section contains a table of modem parameters.
 

Model	COMTECH 570L and ROSS
Signal level	8 dB
RX IF frequency	1770.900000 MHz
TX IF frequency	1316.580000 MHz
TX allowed	On
- TX**: This section contains a table of transmitter parameters.
 

BUC TX	On
BUC output power	■■■■

A **Refresh** button is located at the bottom of the main content area.

Figure 6-2: SAILOR 900 VSAT Dashboard

When the Dashboard is displayed you have verified that the connection to the SAILOR 900 VSAT can be established. The web interface is ready for use. You can continue to configure the system.

If you cannot establish a connection there might be problems with the Proxy server settings of your PC. See *Proxy server settings in your browser* on page 6-15 for further information. For a detailed introduction to the web interface see *Overview and dashboard* on page 6-13. If you want to use another LAN port you must configure it according to your network requirements. For information how to configure the LAN connectors see *Configuring the LAN network* on page 6-26.

## 6.2 Calibration of the SAILOR 900 VSAT

You must align the ADU with the vessel's gyro compass. To do this, you make an azimuth calibration, i.e. you determine the offset of the ADU zero direction to the bow-to-stern line of the ship. This procedure is fully automatic.

You can enter the satellite data for calibration directly on the calibration page or you can define a Service profile to be used in the calibration. After the calibration you create the satellite and VSAT modem profiles you want to use during normal operation, and you can set up blocking zones for the specific installation.

**Important**

You must logon as an administrator to do a calibration.  
See *Administration* on page 6-39.

For a detailed introduction to the web interface see *Overview and dashboard* on page 6-13.

The following sections describe the steps for a successful calibration:

- *Setup of a service profile for calibration*
- *Vessel heading & calibration of azimuth and cable*
- *Flow chart for azimuth and cable calibration*
- *Line up procedure*
- *SAILOR 900 VSAT fixed TX gain principle*

### 6.2.1 Setup of a service profile for calibration

To prepare for calibration you can set up a service profile for calibration. Use this approach if you do not want to enter the satellite parameters directly on the calibration page.

To setup a service profile do as follows:

1. Select **SETTINGS > Satellite profiles > New entry**. Enter the name of the satellite profile for calibration (a name of your own choice).
2. Select the VSAT modem profile **Service & Calibration** from the drop-down list.

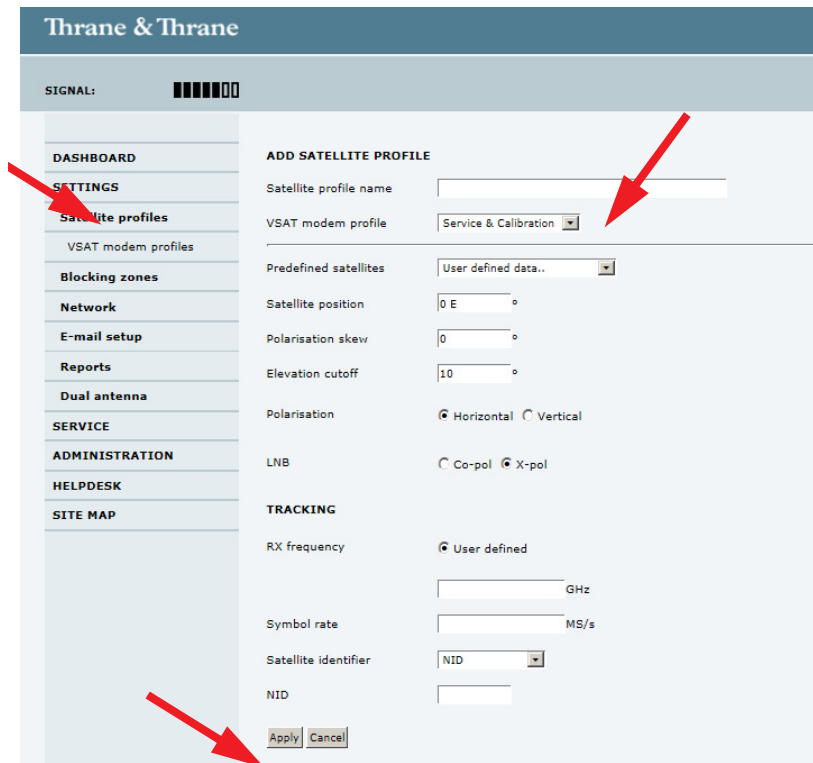

Figure 6-3: Service profile for calibration

3. Enter the data for the satellite that you want to use as a calibration reference. You can enter the satellite data manually or select a satellite from the list of predefined satellites (Eutelsat). For satellite information see *DVB-S satellites* on page E-1 or [www.lyngsat.com](http://www.lyngsat.com).

Note the following calibration requirements:

Satellite requirements for successful calibration	
Elevation	Elevation angle: 5 — 70 degrees Not allowed for calibration: Inclined orbit.
System encryption	DVB-S or DVB-S2
Polarisation	Horizontal or vertical polarisation. Not allowed: Left-hand circular (L) or right-hand circular (R).
Symbol rate	The DVB symbol rate must be >5 Ms/s.
NID	Preferably a unique NID (ONID). An azimuth calibration without NID can be useful in regions where the satellite operators do not broadcast NID (US, China, Australia etc.). For NID=0 the NID is not used when checking the satellite link.

Table 6-1: Satellite requirements for elevation and carrier

Elevation cutoff: Not relevant for calibration.



LNB: Co-pol or X-pol, use this for test if both the LNBS and RX cables function properly in case of issues with the reception of a signal. The polarisation must remain the same as stated for the transponder used for the azimuth calibration. The antenna will just turn the polarisation motor 90 degrees to use the other LNB to receive the same signal.

4. Click **Apply** to save the settings for the service profile for calibration. The system is ready for the azimuth and cable calibration.

## 6.2.2 Vessel heading & calibration of azimuth and cable

Access the page for heading and calibration through **SERVICE > Calibration**.

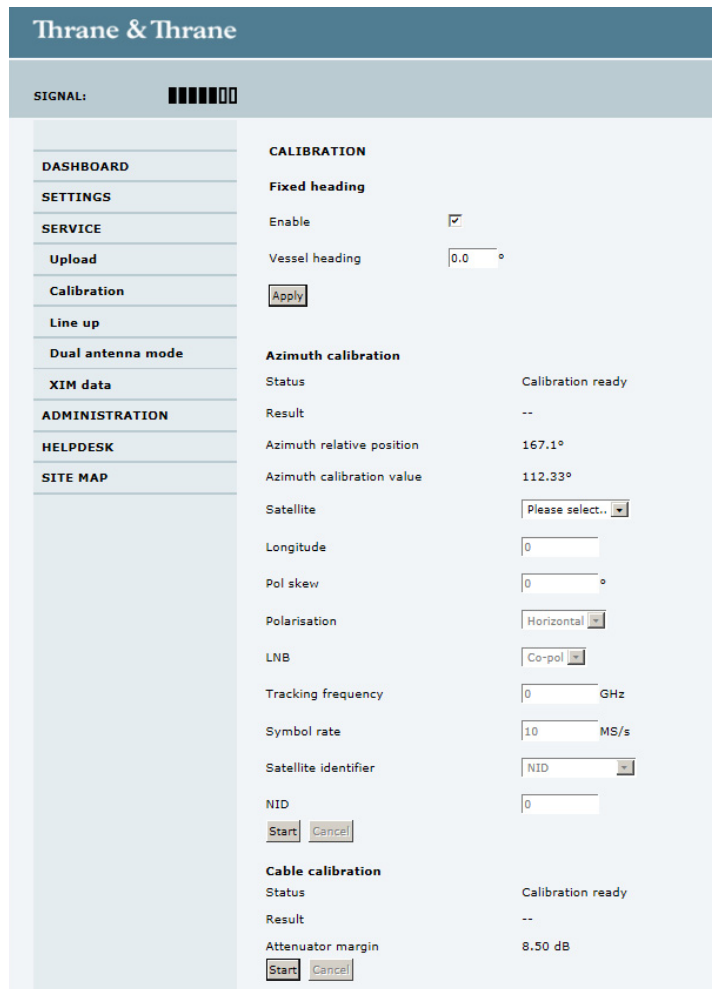

Figure 6-4: Web interface: SERVICE, Calibration

**Note**

If you do not want to enter the satellite data on the calibration page you can set up a dedicated service profile for calibration, see 6.2.1.

Check that the satellite transponder is visible from the location of the installation and at an elevation angle between 10 and 70 degrees.

## Fixed heading

**Do not use fixed heading for vessels!** Use fixed heading only for fixed installations like remote areas or oil rigs, during training and test.

You can enable fixed heading and enter the fixed heading in degrees. Click **Apply**.

**Note**

If you change the heading settings you must make an azimuth calibration afterwards.

## Azimuth calibration

Azimuth calibration is done toward a satellite of a known position. After finding the satellite, the system can calculate the azimuth offset of the ADU installation. The satellite and transponder properties for the calibration can be selected from a list of reference satellites or supplied manually. The calibration has 2 steps: Azimuth calibration and cable calibration.

There are 2 ways to make an azimuth calibration:

- Using a service profile.
- Using user defined input on the calibration page.

To make an azimuth calibration with a service profile, do as follows

1. Click **SERVICE > Calibration**.
2. There are 2 possibilities:
  - a) Select the service profile in the drop down list Satellite, see *Setup of a service profile for calibration* on page 6-3. All profiles with the VSAT modem Service & Calibration are displayed in the list.
  - b) Select the satellite User defined and enter the satellite data for the reference satellite.

**Important**

**Do not refresh the browser window during calibration, this will interrupt and restart the calibration procedure.** The screen is not automatically updated when new data are available from the SAILOR 900 VSAT.

You may click the button **Refresh** in the web interface to update the screen.

3. Click **Start** in the section **Azimuth calibration** and wait typically 5 minutes for the calibration to finish. After finished calibration click the button **Refresh**. A message is displayed when the calibration has been completed.
4. Click **Start** below **Cable calibration** and wait typically 10 minutes for the calibration to finish. A message is displayed when the calibration has been completed successfully.

This screen shows how much attenuation margin that is left for the antenna cable. This indicates whether the antenna cable and connectors are in good condition and well crimped.

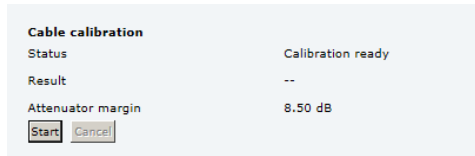

Figure 6-5: Web interface: SERVICE, Calibration, cable attenuator margin

It is recommended to make a cable calibration when servicing the system to check if the antenna cable is still in good order. If the attenuator margin changes by 2 dB or more after a cable calibration, it is recommended to do a 1 dB compression measurement to verify that the VAST modem configuration is correct.

To make an azimuth calibration with user defined input, do as follows:

1. Select User defined in the Satellite drop down list.
2. Type in the longitude and polarisation skew of the satellite. The polarisation skew is provided by the satellite operator, it is typically 0 degrees. For satellite data see *DVB-S satellites* on page E-1, [www.lyngsat.com](http://www.lyngsat.com).

**Important** The calibration function is not able to verify the correctness or precision of the supplied longitude. It is therefore important to supply the correct longitude including the first decimal.

3. Select the polarisation of a transponder and type in its frequency and symbol rate.
4. Select which satellite identifier to use for identification of the signal.

Satellite identifier	NID value	Description
NID	0	Satellite identifier is not used.
NID	1–65535	Supplied NID is matched against Network ID broadcast by the satellite.
Orbital position	n.a.	Supplied longitude is matched with orbital position broadcast by satellite. Not all service providers broadcast the orbital position.

Table 6-2: Satellite identifier and NID values

5. Click **Start** and wait typically 5 minutes for the calibration to finish. A progress bar is shown during calibration and a message is displayed when the calibration has

completed. In case of failure, see the table in the following section for a description of error codes during calibration.

**Important**

It is strongly recommended to verify the result of a calibration performed with user defined data. This can be done by making a new calibration on a different satellite and verify that the resulting Azimuth calibration value differs less than one degree.

6. Click **Start** below **Cable calibration** and wait typically 10 minutes for the calibration to finish. A message is displayed when the calibration has been completed successfully.

The following table shows the error codes that might be displayed during a calibration.

Error code	Explanation
1	The elevation of the selected satellite is too low. Select another satellite.
2	The elevation of the selected satellite is too high. Select another satellite.
4	The calibration values could not be saved. Possibly due to defective hardware.
5	The antenna could not point with sufficient precision. Check that the antenna is mounted in a stable way. Other possible causes might be electrical or mechanical faults.
6	No signal received. Check that there is free line of sight. Try again or try with another satellite.
7	RF setup error, e.g. missing or invalid TX frequency.
8	Invalid satellite, e.g. satellite not visible.

Table 6-3: Possible error codes during calibration

The SAILOR 900 VSAT is calibrated now. If the calibration failed there will be a message on the calibration screen.

### 6.2.3 Flow chart for azimuth and cable calibration

The following flow chart gives an example of an azimuth and cable calibration.

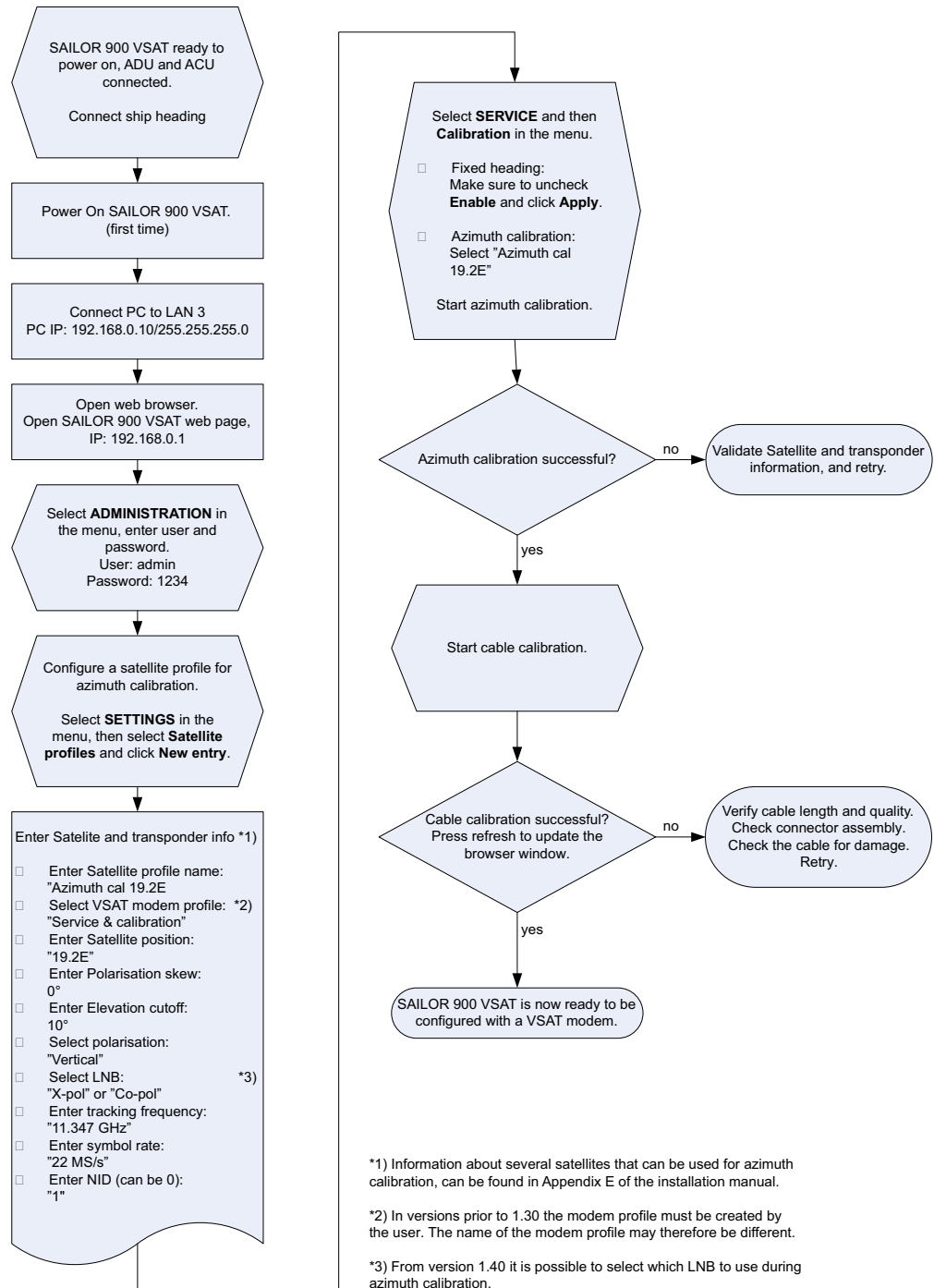

Figure 6-6: Example for azimuth and cable calibration — step by step

## 6.2.4 Line up procedure

**Note** | The ship must not move during the calibration procedure.

The SAILOR 900 has been tested at factory online on a live satellite link to calibrate the TX polarisation unit. You can fine-tune the TX polarization by doing a line up as described below. To do the line up, do as follows:

1. Open the web interface of the SAILOR 900, for instructions see *Connecting to the web interface* on page 6-1.
2. Create a VSAT modem profile and a satellite profile using the previously created VSAT modem profile (See *Setup of a service profile for calibration* on page 6-3).
3. Go to the page **SERVICE > Line up**. As soon as the antenna is in tracking mode and points to the satellite, the text next to **Status** shows **Please wait. Improving tracking**. This may take up to 2 minutes. Wait until the text shows **Ready for activation**.

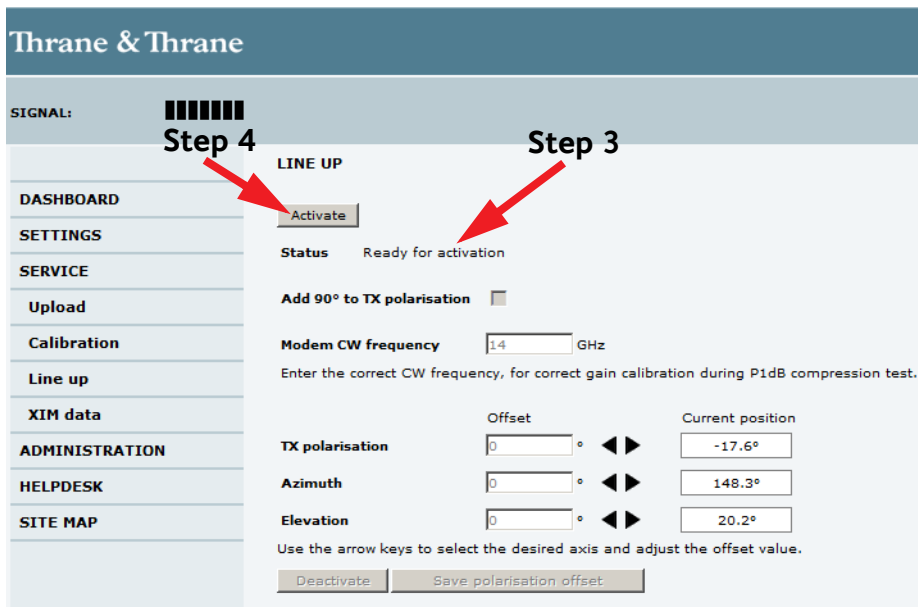

Figure 6-7: Web interface: SERVICE, Line up: Ready for activation

- Click the button **Activate** and wait until the status field shows **Antenna ready**. Follow the instructions from your service provider.

The screenshot shows the Thrane & Thrane web interface. On the left is a navigation menu with options: DASHBOARD, SETTINGS, SERVICE, Upload, Calibration, Line up, XIM data, ADMINISTRATION, HELPDESK, and SITE MAP. The main content area is titled 'LINE UP' and shows the following configuration:

- Activate** button
- Status**: Antenna ready
- Add 90° to TX polarisation**:
- Modem CW frequency**:  GHz
- Enter the correct CW frequency, for correct gain calibration during P1dB compression test.
- TX polarisation**:  °    °
- Azimuth**:  °    °
- Elevation**:  °    °
- Use the arrow keys to select the desired axis and adjust the offset value.
- Deactivate** button and **Save polarisation offset** button

Figure 6-8: Web interface: SERVICE, Line up: Antenna ready

- Enter the Modem CW frequency (Continuous Wave) in GHz. This is provided by the satellite operator, typically when talking to the satellite operator on the phone before starting the line up.
- Adjust the TX polarisation as instructed by the service provider. If needed, add 90 degrees to the TX polarisation by selecting the field.
- Set the values as advised by the service provider:
  - TX polarisation
  - Azimuth
  - Elevation
- To save the TX polarisation offset value, click the button **Save polarisation offset**.
- Follow the instructions from the service provider to make a P1dB compression test (VSAT modem).
- Click the button **Deactivate** to finish the line up procedure.

When finished, the saved value for TX polarisation is visible the next time the line up procedure is selected.

### 6.2.5 SAILOR 900 VSAT fixed TX gain principle

The SAILOR 900 VSAT uses a new transmitter chain concept. After calibration it provides a fixed gain of 44 dB from the Tx-port of the ACU to the output of the BUC. Advantages of the fixed TX gain principle are:

- Fixed TX gain over frequency and cable length
- TX gain independent of antenna cable length
- Utilization of the full 8W BUC power over frequency
- P1dB compression point the same over frequency

When installing the SAILOR 900 VSAT you make a cable calibration. At that point every installation finds the same P1dB compression setting regardless of cable length. The P1dB compression point is approximately -5 dBm at the ACU Tx-port. Additionally the SAILOR 900 VSAT system monitors the TX gain in real time.

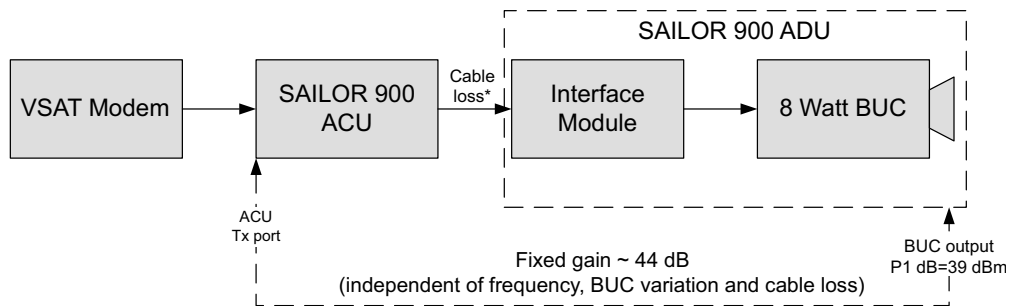

Figure 6-9: Fixed TX gain principle

\* You find the maximum cable loss at *Maximum allowed RF loss in the ADU cable* on page 3-21.

**Example:** ACU Tx-port power: -5dBm > BUC output = +39 dBm (compression)



## 6.3 Configuration with the web interface

### 6.3.1 Overview and dashboard

#### Topics in the web interface

Use the site map to get an overview over the existing menus, submenus and topics. You can click on each menu in the site map to go directly to the page or display the respective submenu.

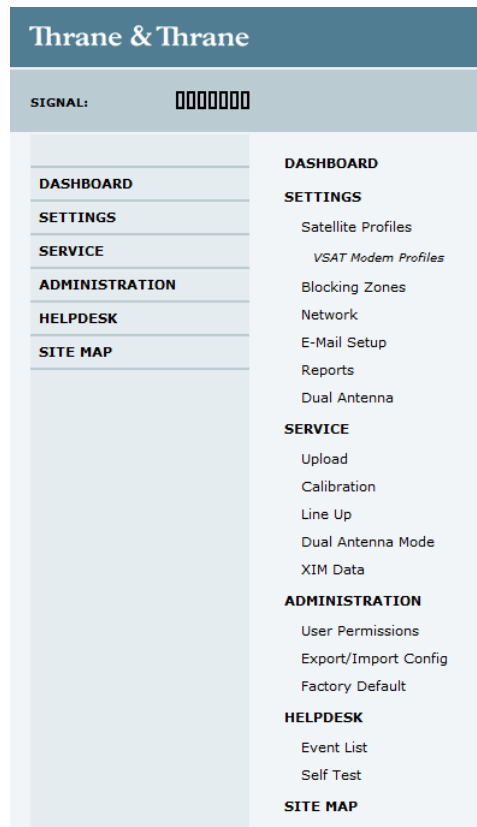

Figure 6-10: Topics in the web interface (SITE MAP)

## Dashboard and navigation

The Dashboard is the first screen that is displayed when the user or administrator enters the IP address of the web interface of the ACU. The Dashboard is used for viewing properties and status of the ACU and ADU.

The web interface consists of the following sections:

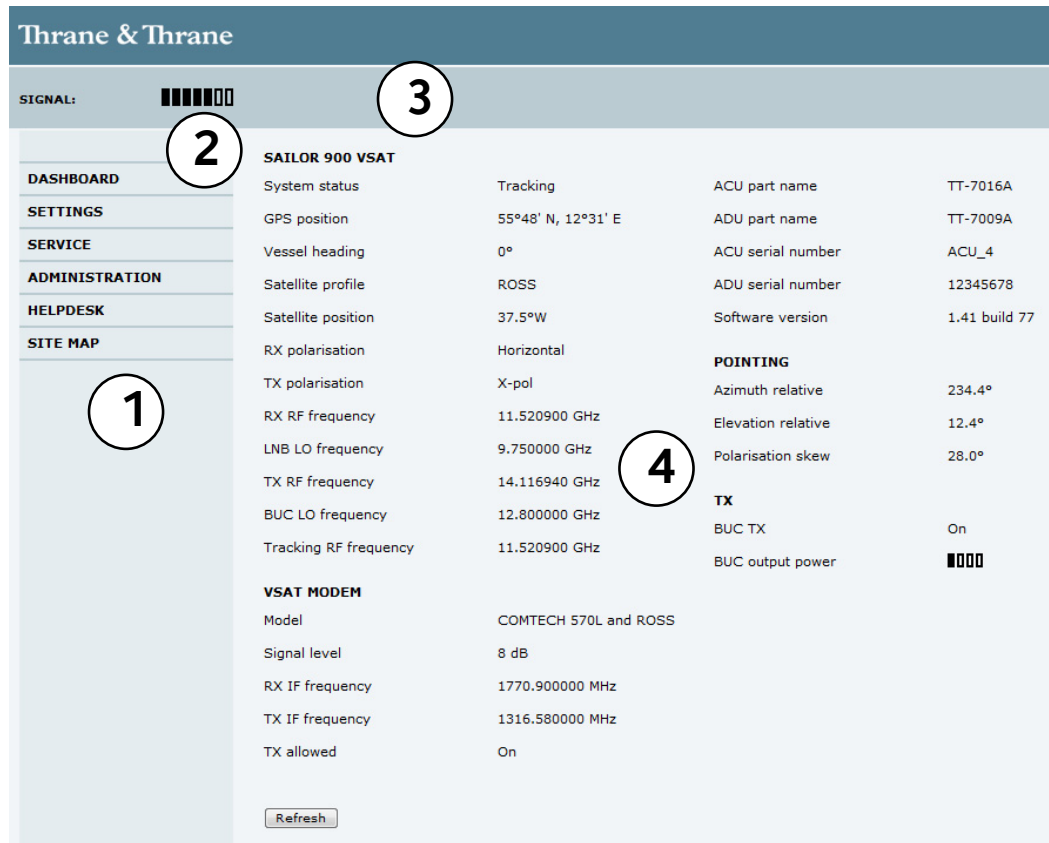

Figure 6-11: Web interface: DASHBOARD

1. The **navigation pane** holds the main menu. Clicking an item in the menu opens a submenu in the navigation pane or a new page in the contents section.
2. The **signal status field** shows the tracking signal strength of the antenna. The signal strength can vary during operation, depending on the current position relative to the satellite. The signal strength of the VSAT modem is shown at VSAT MODEM, Signal level.
3. The **icon bar** shows icons for active events, when relevant. For explanations of the icons, see the next section, *Icons in the icon bar*.
4. The **contents section** shows the page selected in the navigation pane. This section is used for viewing or changing settings, or for performing actions.  
For a description of the individual items in the contents section see *Information fields on the Dashboard* on page 6-16.

## Icons in the icon bar

The following icons may appear in the icon bar in the web interface:

Icon	Explanation
	An event is active. Click the icon to see a list of active events. For explanations of the event messages, see <i>Event list</i> on page 8-2 and <i>Event messages – overview</i> on page G-1. Note that this icon will remain in the icon bar as long as the event is active.

Table 6-4: Web interface: Event icon

## Navigating the web interface

- **To expand a menu**, click the menu in the navigation pane.
- **To access status and settings**, click the relevant subject in the navigation pane or click the relevant icon in the icon bar. The status or settings are displayed in the contents section.
- **To get an overview over the submenus available**, click **SITE MAP** in the navigation pane. Click on items in the site map to go directly to the relevant location.

**Note** You can give access to some configuration settings for users that are not administrators. For information on how to set up user permissions, see *Setting up user permissions* on page 6-41.

## Proxy server settings in your browser

If you are connecting your computer using a LAN or WLAN interface, the **Proxy server** settings in your browser must be disabled before accessing the web interface. Most browsers support disabling of the Proxy server settings for one specific IP address, so you can disable Proxy server settings for the web interface only, if you wish. Consult your browser help for information.

To disable the use of a Proxy server completely, do as follows:

**Note** The following description is for **Microsoft Internet Explorer**. If you are using a different browser, the procedure may be different.

1. In Microsoft Internet Explorer, select **Tools > Internet Options > Connections > LAN Settings**.

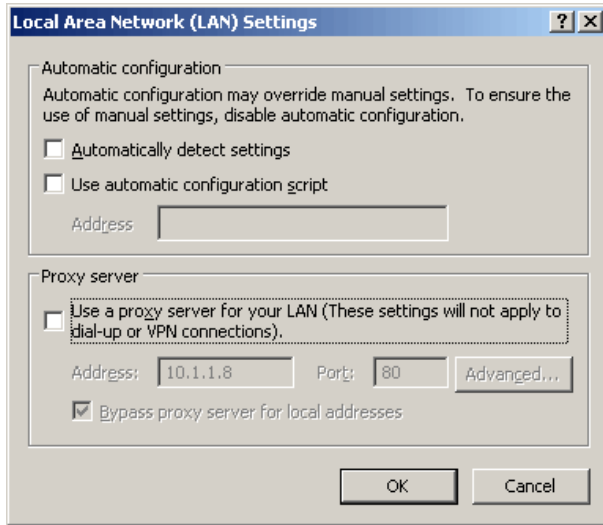

2. Clear the box labeled **Use a proxy server for your LAN**.
3. Click **OK**.

When the proxy server settings are disabled, close and restart your browser.

You may need to change this setting back on return to your Internet connection.

### Connecting a PC

To connect your PC to the ACU see *Connecting to the web interface* on page 6-1. If you want to use another LAN port than LAN 3 you must configure it according to your network requirements. For information how to configure the 4 LAN connectors see *Configuring the LAN network* on page 6-26.

### Information fields on the Dashboard

SAILOR 900 VSAT parameter	Description
System status	<p>Current status of the SAILOR 900 VSAT.</p> <p><b>Examples:</b></p> <p><b>Not ready</b> (waiting for input from GNSS, e.g. GPS)  <b>Ready</b> (waiting for data from the VSAT modem or no satellite profile selected)  <b>Pointing antenna</b> (locating the satellite)  <b>Acquiring signal</b> (acquiring the satellite signal)  <b>Tracking</b> (tracks the current satellite)  <b>No Tx zone</b> (antenna is pointing in a no TX zone; TX is off)  <b>Blocking zone</b> (antenna is pointing into a blocking zone)  <b>Service switch</b> (service switch in ADU activated)  <b>Safe mode</b> (error, followed by an error description)</p>
GPS position	Current position of the vessel, reported by the GPS module

Table 6-5: Web interface, DASHBOARD, SAILOR 900 VSAT parameters

SAILOR 900 VSAT parameter	Description
Vessel heading	Ship's heading in degrees with reference to North, provided by the ship's gyro.
Satellite profile	Name of the currently active satellite profile.
Satellite position	Position of the satellite selected in Satellite profile.
RX polarisation	Horizontal or vertical.
TX polarisation <sup>a</sup>	Co-pol or X-pol, auto-selected by VSAT modem
RX RF frequency <sup>a</sup>	Ku band receiving frequency, auto-selected by VSAT modem
LNB Lo frequency <sup>a</sup>	Auto-selected by VSAT modem
TX RF frequency <sup>a</sup>	Auto-selected by VSAT modem
BUC Lo frequency	12.8 GHz (system parameter)
Tracking RF frequency	Current RF tracking frequency.
ACU part name, ADU part name, ACU serial number, ADU serial number, Software version	Part names, serial numbers for ACU and ADU, software version of the SAILOR 900 VSAT.

Table 6-5: Web interface, DASHBOARD, SAILOR 900 VSAT parameters (Continued)

a. Can be altered when using a generic modem profile.

VSAT MODEM parameter	Description
Model	VSAT modem name, entered in <b>SETTINGS &gt; VSAT modem profiles</b> .
Signal level	Current input signal level from VSAT modem. iDirect openAMIP modem: (PWR) 0-500, delivered by the connected modem. For values <250 the antenna searches after a new signal. Other modem: Signal level in dB.
RX IF frequency	Read out from VMU.
TX IF frequency	Read out from VMU.

Table 6-6: Web interface, DASHBOARD, VSAT MODEM parameter

VSAT MODEM parameter	Description
TX allowed	On or Off. Indicates if the VSAT modem supplies the 10 MHz reference signal on its TX connector (On) and if an iDirect OpenAMIP modem indicates modem Locked and Tx ON in the OpenAMIP message L (L 1 1).

Table 6-6: Web interface, DASHBOARD, VSAT MODEM parameter (Continued)

POINTING parameter	Description
Azimuth relative	Current value for azimuth, relative to the vessel heading.
Elevation relative	Current value for elevation, relative to the vessel.
Polarisation skew	Current value for polarisation skew.

Table 6-7: Web interface, DASHBOARD, POINTING parameter

TX parameter	Description
BUC TX	On or Off. Shows if the SAILOR 900 VSAT has enabled the BUC or not. It is the same TX ON/TX OFF as shown in the display of the ACU, see <i>ACU display and keypad</i> on page 6-45.
BUC output power	See sections below this table.

Table 6-8: Web interface, DASHBOARD, TX parameter

### TX BUC output power information

The BUC TX information is displayed on the DASHBOARD. The BUC TX indicates if the SAILOR 900 VSAT has enabled the BUC or not. It can show BUC Tx On or Off. This information is also shown in the display of the ACU as TX ON or TX OFF.

The SAILOR 900 VSAT shows BUC TX On when the following conditions are met:

- The SAILOR 900 VSAT must sense the 10 MHz Tx reference signal from the connected VSAT modem.
- The VSAT modem must have Rx lock.
- The antenna must point correctly to the satellite.
- The antenna must be in tracking mode.

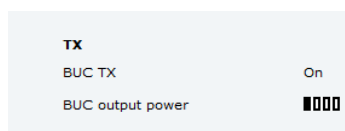

Figure 6-12: Web interface: DASHBOARD, TX - BUC output power (example)

The BUC output power indicates if the BUC is transmitting or not. This is a unique feature of the SAILOR 900 VSAT antenna. A built-in power detector in the OMT developed by

Cobham SATCOM makes it possible to measure the power within a time window to be able to catch short TX bursts. The power within the window is averaged and shown in the BUC output power bar graph on the DASHBOARD. Not that this indicator is an averaged signal, it is not a real-time indicator. After measuring a signal burst the bar graph falls slowly in order for the user to be able to see short TX bursts.

The BUC output power indicator is very useful during installation as the service engineer knows whether the antenna is transmitting or not and that the hub should be able to monitor the transmission. It is also very useful when doing line up with the hub as the service engineer can monitor the TX BUC output power level on the DASHBOARD and watch when the output power approaches the P1dB compression point which is at 4 bars.

**Note** Refresh the web page manually from time to time in order to monitor changes to the BUC output power bars.

## 6.3.2 Satellite profiles and VSAT modem profiles

### Satellite profiles

On the page **Satellite profiles** you add, edit and delete satellite profiles. A satellite profile contains all settings that are necessary for a successful connection to the satellite, including a VSAT modem profile. Most of the data you have to fill in are provided by your VSAT service provider.

You must activate one satellite profile.

**Note** You must add at least one VSAT modem profile before you can add a satellite profile. See *VSAT modem profile – New entry and Edit* on page 6-22.

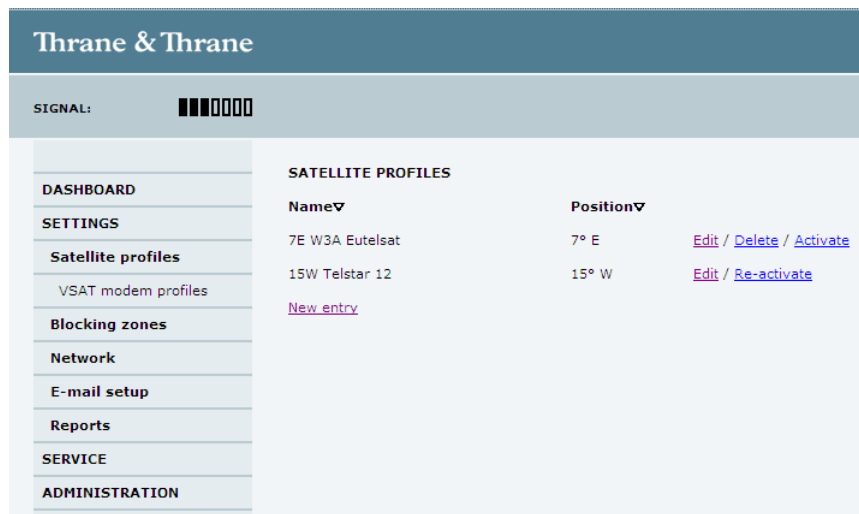

Figure 6-13: Web interface: SETTINGS - list of satellite profiles (example)

## Satellite profiles – New entry and Edit

Each satellite profile has one assigned VSAT modem profile.

The screenshot shows the 'Thrane & Thrane' web interface. On the left is a sidebar menu with categories: DASHBOARD, SETTINGS (with sub-items: Satellite profiles, VSAT modem profiles, Blocking zones, Network, E-mail setup, Reports, Dual antenna), SERVICE, ADMINISTRATION, HELPDESK, and SITE MAP. The main area is titled 'ADD SATELLITE PROFILE'. It features a 'SIGNAL' indicator with a bar chart. The configuration fields are as follows:

- Satellite profile name: North Sea (ASTRA 4A (DVB))
- VSAT modem profile: Generic
- Predefined satellites: User defined data..
- Satellite position: 4.8 E
- Polarisation skew: 0
- Maximum inclination: 0
- Elevation cutoff: 10
- RX polarisation:  Vertical
- TX polarisation:  X-pol
- RX IF frequency: 1573 MHz
- LNB LO frequency: 10.250000 GHz
- RX RF frequency: 11.823000 GHz
- TX RF frequency: 14.000000 GHz
- TRACKING:
  - Tracking type: DVB-S / DVB-S2
  - RX frequency:  VSAT modem
  - Symbol rate: 27.500 MS/s

Buttons for 'Apply' and 'Cancel' are located at the bottom of the form.

Figure 6-14: Web interface: SETTINGS, Satellite profiles — new entry (example)

To add or edit a satellite profile, do as follows:

1. Go to **SETTINGS** or **Satellite profiles** and click **Edit** or **New entry**.
2. Enter or edit the Satellite profile name.

**Note** It is helpful to assign a name containing the location where the Satellite profile is to be used (e.g. *Gulf of Mexico* or *North Sea*) and possibly the provider.

3. Select a VSAT modem profile. The page automatically displays the parameters available for the selected VSAT modem profile.  
For instruction how to add a VSAT modem profile see *VSAT modem profile – New entry and Edit* on page 6-22.
4. Enter the data for the satellite that you want to use. For satellite data see *DVB-S satellites* on page E-1 or [www.lyngsat.com](http://www.lyngsat.com).
5. Polarisation skew: See documents from VSAT provider.



6. At Elevation cutoff enter the minimum elevation angle for the antenna to function in accordance with ETSI (ETSI EN 302 340) and FCC (FCC §25.205) regulations.
  - **ETSI (ETSI EN 302 340):** The minimum elevation angle depends on the Tx bandwidth and the nominal power of the VSAT modem, see the table below.

Bandwidth	Nominal VSAT modem power								
	- 22 dBm	- 20 dBm	- 18 dBm	- 16 dBm	- 14 dBm	- 12 dBm	- 10 dBm	-8 dBm	-6 dBm
Eirp@14.25 GHz <sup>a</sup>	63.4 dBm	65.4 dBm	67.4 dBm	69.4 dBm	71.4 dBm	73.4 dBm	75.4 dBm	77.4 dBm	79.4 dBm
64 kHz	3°	4°	4°	5°	6°	7°	8°	10°	12°
128 kHz	3°	4°	4°	5°	6°	7°	8°	10°	12°
256 kHz	3°	4°	4°	5°	6°	7°	8°	10°	12°
512 kHz	3°	4°	4°	5°	6°	7°	8°	10°	12°
1024 kHz	3°	4°	4°	5°	6°	7°	8°	10°	12°
2048 kHz	3°	3°	3°	4°	5°	5°	6°	8°	9°
4096 kHz	3°	3°	3°	3°	4°	4°	5°	6°	7°
8192 kHz	3°	3°	3°	3°	3°	3°	4°	5°	5°
16384 kHz	3°	3°	3°	3°	3°	3°	3°	4°	4°
32768 kHz	3°	3°	3°	3°	3°	3°	3°	3°	3°

Table 6-9: Elevation cutoff (in degrees) versus VSAT modem bandwidth and power

a. Eirp = Fixed system gain 44 dB + antenna gain @ 14.25 GHz 41.4 dB + modem power

- **FCC (FCC §25.205):** 5 degrees

7. Click **Apply** to save the settings for the satellite profile.

## VSAT modem profiles

A VSAT modem profile contains all VSAT modem settings that are necessary for a successful connection to the satellite. The data you have to fill in are provided by your VSAT service and modem provider. You must add at least one VSAT modem profile.

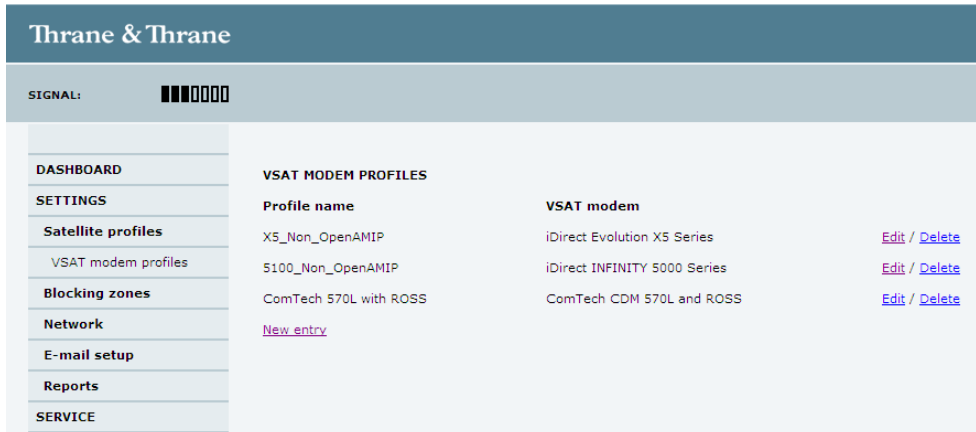

Figure 6-15: Web interface: SETTINGS, VSAT modem profiles — list (example)

To create a new VSAT modem satellite profile, click **New entry**. To edit or delete a VSAT modem profile, click **Edit** or **Delete**.

### VSAT modem profile – New entry and Edit

On the page **VSAT modem profiles** you create, edit or delete VSAT modem profiles. The supported VSAT modem profiles are listed in the drop-down list **VSAT modem profile**.

To add or edit a VSAT modem profile, do as follows:

1. Go to **SETTINGS > VSAT modem profiles** and click **New entry** or **Edit**.

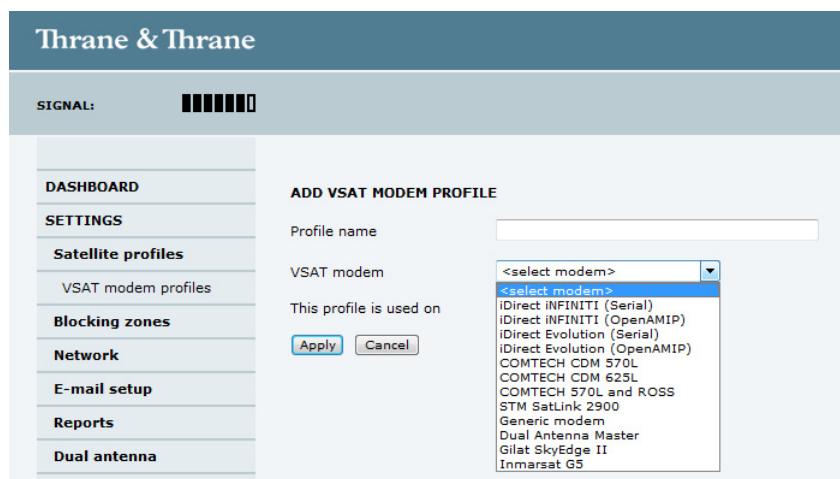

Figure 6-16: Web interface: SETTINGS, VSAT modem profile – supported modems

2. Fill in a VSAT modem profile name of your own choice.
3. Select one of the supported VSAT modems from the drop down list. Once you have selected a VSAT modem, entry fields required for this VSAT modem are displayed. Generic modem: If you have a modem that is not included in the list, select the generic modem. This is mainly used for troubleshooting purposes.

- Fill in or edit the data provided by your VSAT service provider.  
Enter the passwords, if needed.  
Select the VSAT modem baud rate and whether you want to use the 10 MHz reference from the ACU or the VSAT modem.

**Important** The SAILOR 900 VSAT can work either using the Rx or Tx 10 MHz reference signals provided by the modem or using its own built-in 10 MHz reference signal. It is recommended to use the Tx 10 MHz reference signal from the modem.

**For OpenAMIP IP address:** Make sure that you have entered this IP address also for the LAN connector that is used for the OpenAMIP modem, see *Configuring the LAN network* on page 6-26.

- Click **Apply** to add the new profile to the list of VSAT modem profiles or to accept the edits.

For a generic modem you enter all parameters in the satellite profile.

**ADD SATELLITE PROFILE**

Satellite profile name:

VSAT modem profile:

---

Satellite position:  °

Polarisation skew:  °

Maximum inclination:  °

RX polarisation:  Horizontal  Vertical

TX polarisation:  Co-pol  X-pol

RX IF frequency:  MHz

LNB LO frequency:

RX RF frequency:  GHz

TX RF frequency:  GHz

**Tracking**

RX frequency:  VSAT modem  User defined  
 GHz

DVB-S / DVB-S2

Symbol rate:  MS/s

NID:

DVB power

Narrow band

VSAT modem RSSI

Figure 6-17: Satellite profile for generic modem

### 6.3.3 Setting up Blocking zones (RX and TX)

On this page you define blocking zones, i.e. NO TX and RX zones, enter azimuth values and elevation angles for each blocking zone.

You must select **Active** to enable a blocking zone.

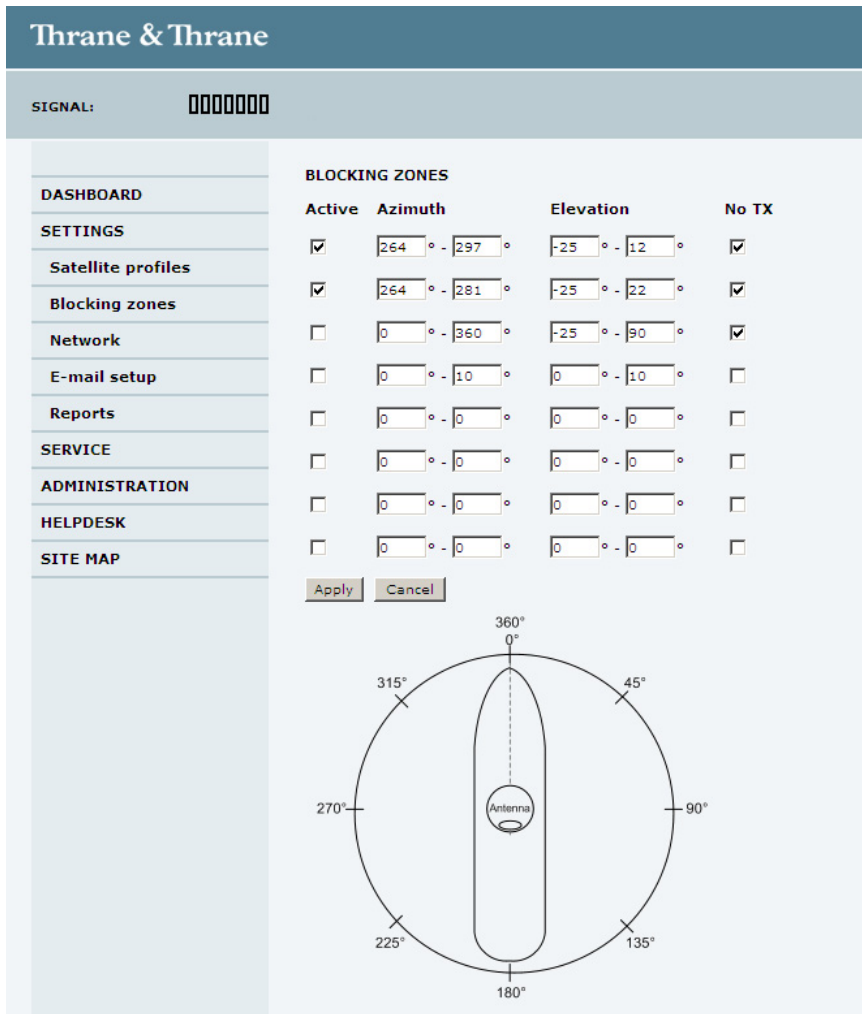

Figure 6-18: Web interface: SETTINGS, Blocking zones — azimuth and elevation

To define and set a blocking zone, do as follows:

1. Select **SETTINGS > Blocking zones**.
2. Select **Active** to enable the blocking zone.

3. **Azimuth:** Enter start and stop azimuth value in degrees for the blocking zone. Values allowed: 0 to 360 degrees. Enter clockwise.

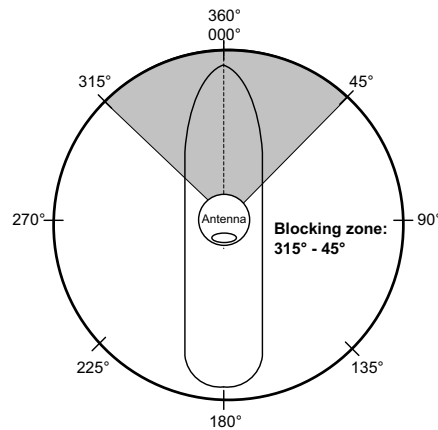

Figure 6-19: Blocking zone, example: 315 - 45 degrees

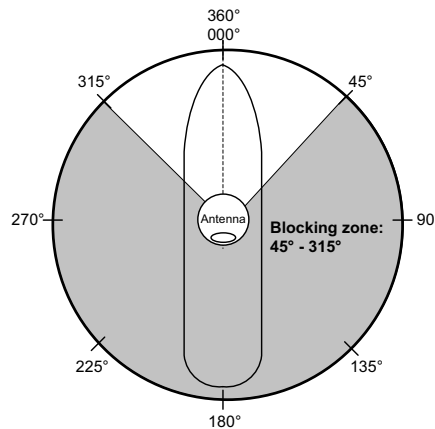

Figure 6-20: Blocking zone, example: 45 - 315 degrees

4. **Elevation:** Enter the start and stop elevation angle for the blocking zone. If you enter nothing, there will be no blocking zone. Values allowed: -30 to 90 degrees.

**Important** You must enter 2 different elevation angles to have an active blocking zone.

5. Select **No TX** for zones if you don't want the system to transmit. If not selected, the system also transmits when pointing through areas with blocking objects. The VSAT modem will shut off for TX if no signal is received.
6. Click **Apply** to save the blocking zones.

### 6.3.4 Configuring the LAN network

You can enter a host name. The host name helps identifying the SAILOR 900 VSAT system when sending e-mail reports. The ACU has four 10/100 Mbit Ethernet ports labelled LAN port 1, 2, 3 and 4. The ports are divided in three groups, each group operating in its own network. You can setup DNS and Gateway.

To configure the LAN network go to **SETTINGS > Network**.

**NETWORK**

Host name:

**LAN port 1: VSAT Modem Unit**      **LAN port 2: LAN**  
 Mode:  Static IP  DHCP client      Switched network with LAN port 1

IP address:

Netmask:

DHCP Server:

DHCP Server Start:

DHCP Server End:

---

**LAN port 3: Service**      **LAN port 4: LAN**

Mode: Static IP      Mode:  Static IP  DHCP client

IP address:

Netmask:

DHCP Server:

DHCP Server Start:

DHCP Server End:

**DNS setup**

DNS source:

Primary DNS:

Secondary DNS:

**Gateway setup**

Default gateway source:

Default gateway:

**Zeroconf setup**

Zeroconf source:

Figure 6-21: Web interface: SETTINGS, Network (default settings)

**Important** Make sure that the 3 networks do not use IP address ranges that overlap.

Sections	Preferred use
NETWORK Host name	The host name is used for identifying the ACU in local networks and in e-mail reports. The default host name is acu. You can change the name. Letters (a-z), digits (0-9) and hyphen (-) are allowed as legal characters.  Note: The host name must start with a letter.
LAN Port 1 + 2	LAN port 1 and 2 are switched, i.e. they share the same IP address and operate on the same network. This network is usually connected to the VSAT Modem Unit.  LAN port 1 can be set to static IP (default), DHCP client or DHCP server.  <b>IMPORTANT — OpenAMIP IP modem:</b> Make sure that you have entered this IP address also for the VSAT modem profile of the OpenAMIP modem, see <i>VSAT modem profile – New entry and Edit</i> on page 6-22.
LAN Port 3	LAN port 3 is dedicated as the service port. By default this port has the IP address 192.168.0.1; the current value can be displayed in the ACU display. In a 19” rack mount it is recommended to connect LAN port 3 to the front port (via rear connector, see the figure <i>ACU rack version, connector panel overview</i> on page 4-1), for access to the service port from the rack front.  LAN port 3 can be set to static IP, DHCP client or DHCP server (default).
LAN Port 4	LAN port 4 can be used for connection to the LAN of the vessel or other general purpose.  LAN port 4 can be set to static IP, DHCP client (default) or DHCP server.

Table 6-10: Setup of LAN connectors

### Static IP or DHCP Client

If you select **DHCP client** the network IP address and sub-net mask must be provided by a DHCP server on that network.

If you select **Static IP** address you must specify a unique IP address and a sub-net mask.

### DHCP Server Settings.

On LAN ports 1,3 and 4 you can choose to run a DHCP server. Select the check box **DHCP Server**. The DHCP server settings are only displayed and can be selected when the port mode is set to **Static IP**, otherwise the DHCP server settings are not shown.

The DHCP start and end addresses must be on the same network as the port's static IP.

## DNS setup

If you have access to a Domain Name Server (DNS) you can specify the address of the e-mail server by using the server name instead of its IP address. This can be used in **Outgoing mail server** in *E-mail setup* on page 6-29.

You may statically specify the address of one or two DNS. Select the DNS source as static and fill in IP address or addresses.

Alternatively, if your DHCP server can provide a DNS address and you have selected DHCP client above, then select the same LAN as your DNS source.

## Gateway setup

If the ACU needs to communicate with network units outside the specified sub-nets, you must specify a default gateway (typically a router).

The default gateway can be set as a static IP address. Then set the default gateway source to static and enter the IP address of the default gateway. To remove the default gateway set it to 0.0.0.0.

Alternatively, if your DHCP server is able to provide a default gateway address and you have selected DHCP client above, then select the same LAN as your default gateway source.

## Zeroconf Settings

On LAN ports 1,3 and 4 you can choose to add a zeroconf address in the network (169.254.0.0). This zeroconf address will be in addition to the existing static or DHCP IP address. One port at a time can be enabled.

Zeroconf allows devices to connect to a network automatically.



## 6.3.5 E-mail setup

To be able to send diagnostics and statistics reports using e-mail you must set up a couple of parameters. Contact your IT department for the specific data.

To configure the e-mail setup, do the following:

1. Go to **SETTINGS > E-mail setup**.

Figure 6-22: Web interface: SETTINGS, E-mail setup (example)

2. Enter the data for Outgoing mail server (SMTP), SMTP port number, SMTP authentication, User name and password. This data is typically provided by your IT department.

**Note** You must set **Outgoing mail server** to an IP address if DNS has not been set up in **DNS setup** in *Configuring the LAN network* on page 6-26.

### 6.3.6 Sending statistics reports

SAILOR 900 VSAT can send a statistics report at fixed intervals. This report contains historical information from the SAILOR 900 VSAT of up to 1 month. It is sent as a zipped attachment to an e-mail. The file format is a comma separated value file (csv). The report can then be processed in spreadsheet applications, e.g. Microsoft Excel.

Figure 6-23: Web interface: SETTINGS, Reports (example)

To set up sending a statistics report, do as follows:

1. Configure e-mail first, see *E-mail setup* on page 6-29.
2. Go to **SETTINGS > Reports**.
3. In the section **STATISTICS REPORT** enter the following:
  - Email sender.
  - Email recipients (comma separated).
  - Send interval: Select disabled, day (default) with 2-minute samples, week with hourly samples or month with hourly samples. The report contains statistics data for the selected intervals.
4. Click **Apply**.

You can also send the report at any time by clicking **Send now**. Use **Send now** to validate the e-mail setup. See also *Download of a diagnostic report or a statistics report* on page 8-2.

The following parameters are recorded in the statistics report:

Parameter recorded	Description
Hostname	Host name, entered in the web interface on the page SETTINGS > Network.
ACU SN	ACU serial number
ADU SN	ADU serial number
SW ver.	Software version
System type	SAILOR 900 VSAT

Table 6-11: Statistics report, header record

Parameter recorded	Description
UTC. (s) UTC (YYYY-MM-DD hh:mm)	UTC in seconds and date format for the data set.
RSSI.Av RSSI.Max RSSI.Min	Received signal strength (average, maximum and minimum value) for the sampling interval.
POS.Lat (degree) POS.Long (degree) POS.Valid	Latitude value of position. Longitude value of position. Fix = valid position, No Fix = invalid position.
Heading.Samp (degree) Heading.Max (degree) Heading.Min (degree) Heading.Range (+/-degree)	Ship's heading (sample, maximum and minimum value, range) for the sampling interval. See Figure 6-24: <i>Statistics — how to read data for a range.</i>
Antenna.Azi (degree) Antenna.Azi Max (degree) Antenna.Azi Min (degree) Antenna.Azi Range (+/-degree)	Current antenna azimuth (sample, maximum and minimum value, range) for the sampling interval. See Figure 6-24: <i>Statistics — how to read data for a range.</i>
Antenna.Ele (+/-degree) Antenna.Ele Max (+/-degree) Antenna.Ele Min (+/-degree)	Current antenna elevation (sample, maximum and minimum value) for the sampling interval.
Vsat.rx_lo_freq (GHz) Vsat.tx_lo_freq (GHz)	Rx frequency of VSAT modem for this record. Tx frequency of VSAT modem for this record.
Tracking.rf_freq (GHz) Tracking.type	Tracking RF frequency for this record. Narrow filter, DVB-S2 decoder and VSAT modem RSSI.
Sat.long (degree)	Longitude position of the satellite.

Table 6-12: Parameters recorded in a statistics report

Parameter recorded	Description
Carrier rf.rx (GHz) Carrier rf.tx (GHz)	Rx frequency of carrier for this record. Tx frequency of carrier for this record.
Rx Lock (%) Logon (%)	Rx locked and logon time, in percent, for the sampling interval.
Pos Ok (%)	Valid position, in percent of the sampling interval.
VMU Connection (%)	Link with VSAT modem, in percent of the sampling interval.
Blocking (%)	Ship in blocking zone, in percent of the sampling interval.
DualAntenna.mode DualAntenna.logon_remote (%) DualAntenna.active (%)	Shows the current mode and the time active and remote logon.

Table 6-12: Parameters recorded in a statistics report (Continued)

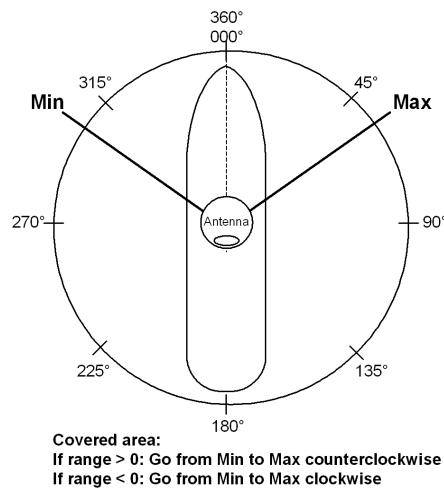

Figure 6-24: Statistics — how to read data for a range

### Processing the statistics report in a spreadsheet application

The statistics report is in a data format that can be imported into spreadsheet applications, e.g. Microsoft Excel, for further processing.

1. Save the zipped file to your computer and extract the text file. The file name contains the identification of the system (example: adu-acu3\_stat\_20111021110901\_day.csv).
2. Open the spreadsheet application, for example Microsoft Excel. On the tab Data click the tab Import from text. Import the unzipped text file and follow the instructions in the wizard. When asked about the delimiter, select 'comma'.

The following figure shows an example of a statistics report in MS Excel 2007.

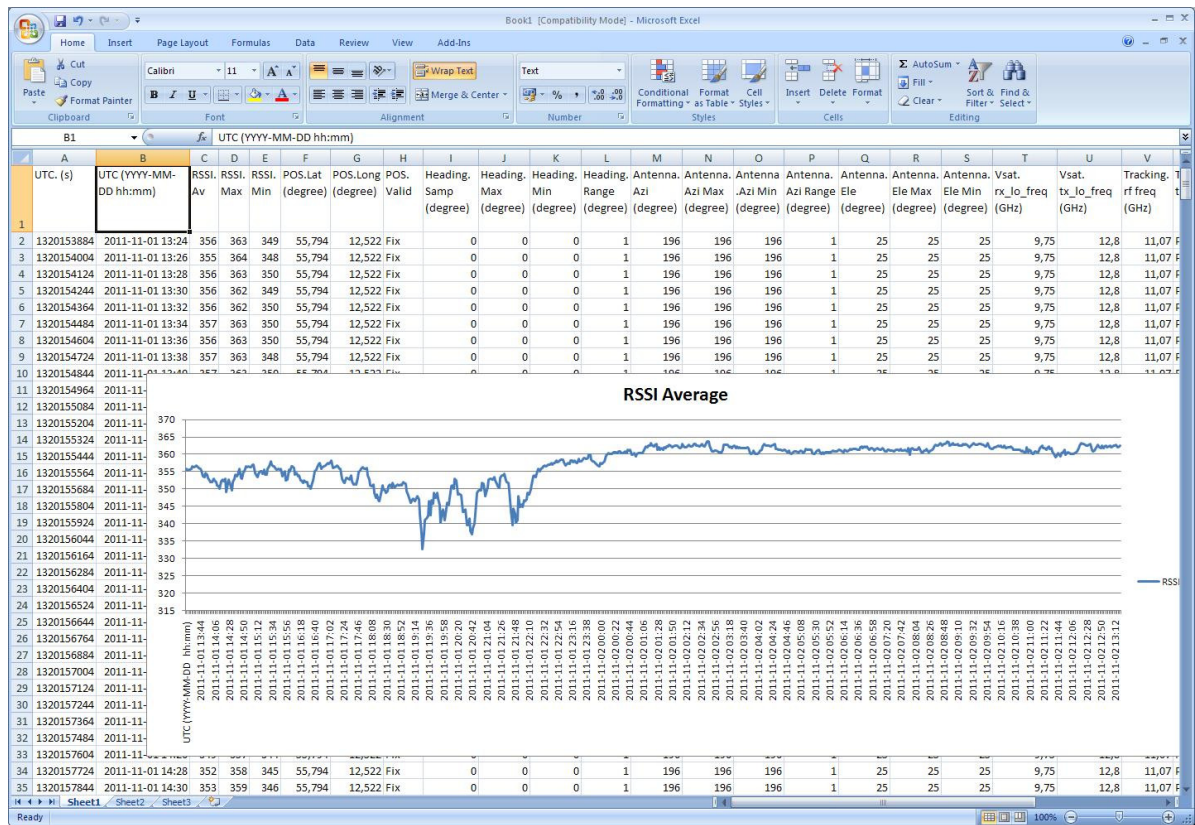

Figure 6-25: Statistics report (example)

### 6.3.7 Sending a diagnostics report

You can send automatically generated diagnostic reports at fixed intervals. The diagnostic report contains information relevant for the service personnel during troubleshooting.

To set up sending a statistics report, do as follows:

1. Go to **SETTINGS > Reports**.
2. In the section **DIAGNOSTICS REPORT** enter the following:
  - Email sender.
  - Email recipients (comma separated).
  - Send interval: Select disabled, day (default) with 2-minute samples, week with hourly samples or month with hourly samples. The report contains statistics data for the selected intervals.
3. Click **Apply**.

To generate a diagnostic report, click **Send now** or go to the page **HELPDESK** and click **Download** to download it directly to your computer. See also *Download of a diagnostic report or a statistics report* on page 8-2.

### 6.3.8 Dual antenna mode (optional)

The following tasks must be taken care of when setting up a dual-antenna system:

- *Configuring the Master ACU*
- *Configuring the Slave ACU*
- *Blocking zone setup*
- *Line up and commissioning*

At the bottom of the DASHBOARD of the web interface there is a section where you can switch over to the other ACU dashboard. Next to **Status** you can see whether the current ACU is active or not.

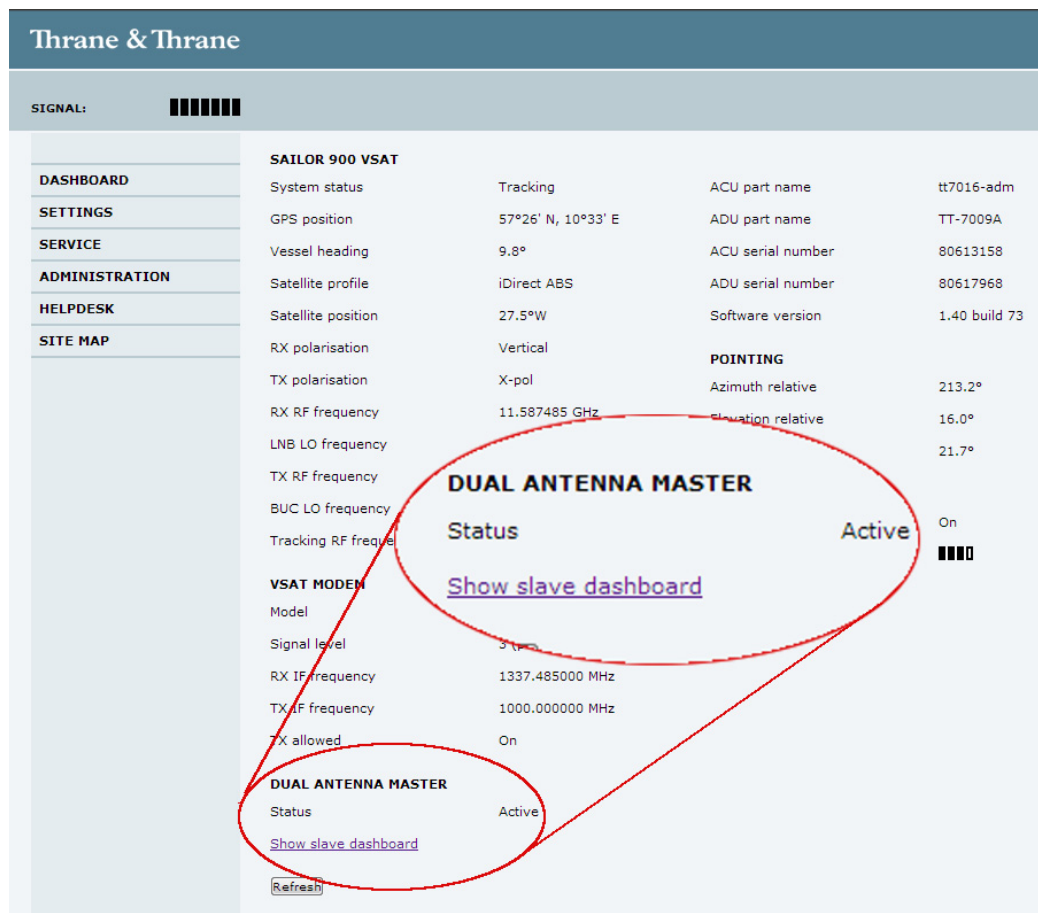

Figure 6-26: Dual-antenna mode, link on DASHBOARD

The dual-antenna system switches between the 2 antennas in the following scenarios:

- When in a programmed blocking zone.
- When the signal is blocked for more than 2 minutes.
- ADU is malfunctioning.

In the statistics report you can get more detailed information on the dual-antenna mode, see also Table 6-12 on page 31.

## Configuring the Master ACU

The Master ACU is configured exactly the same way as a stand-alone SAILOR 900 VSAT system with satellite profiles and VSAT modem profiles. Do as follows:

1. Go to **SETTINGS > Dual antenna**.
2. Select **Enable** and click **Apply**.

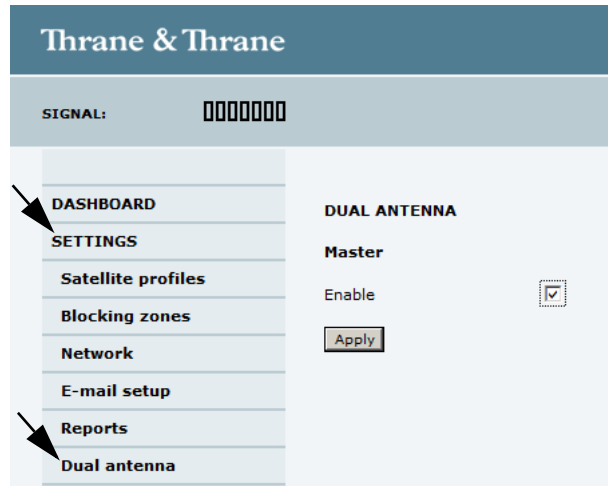

Figure 6-27: Enabling dual-antenna mode in Master ACU

The SAILOR 900 VSAT is now ready to act as Master ACU.

## Configuring the Slave ACU

The Slave ACU is configured to use the Master ACU as VSAT modem profile. The VSAT modem profile must point to the IP address of the Master ACU, that is the IP address of the LAN port at which the Master/Slave communication cable is connected.

1. Add a specific VSAT modem profile for dual-antenna mode, go to **SETTINGS > Satellite profiles > VSAT modem profiles > New entry**.

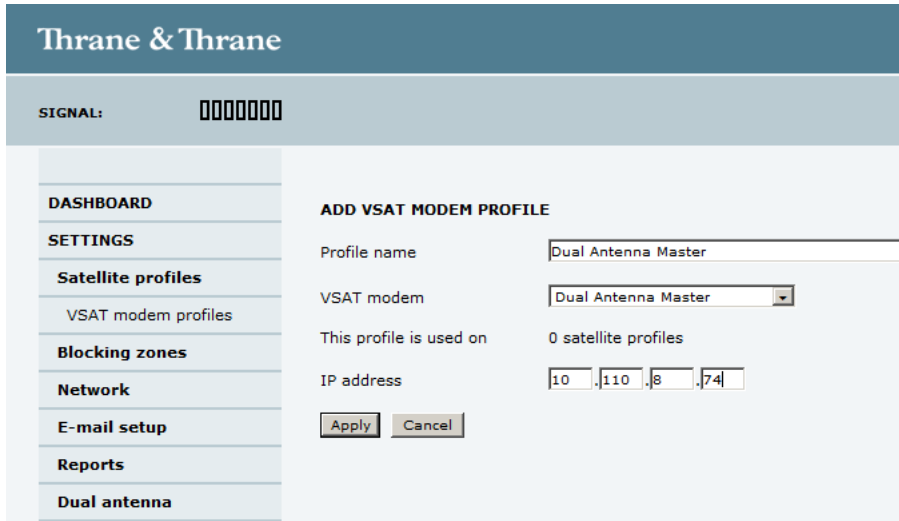

Figure 6-28: Dual-antenna mode, add Slave modem profile

2. Enter the profile name, for example Dual Antenna Master.
3. As VSAT modem select **Dual Antenna Master**.
4. IP address: this is the IP address of the LAN connector at the Master ACU. See *Configuring the LAN network* on page 6-26.
5. Click **Apply**.
6. Add a satellite profile that uses the VSAT modem **Dual Antenna Master**, go to **SETTINGS > Satellite profiles > New entry**.

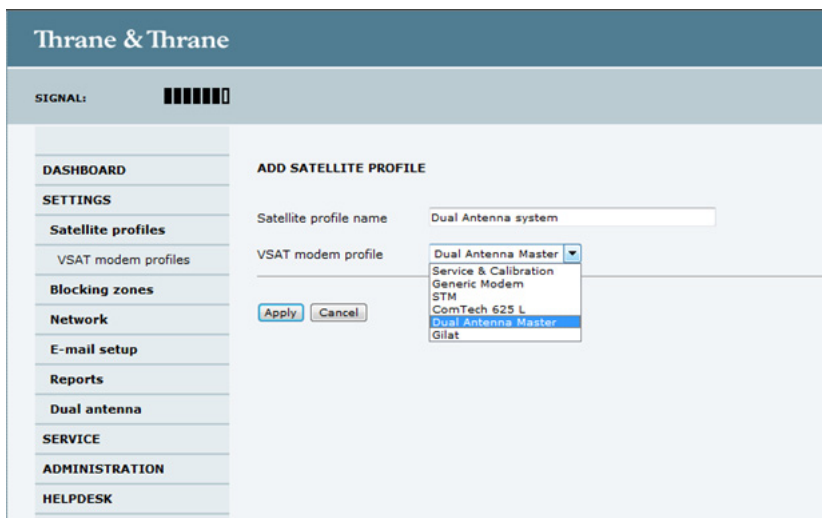

Figure 6-29: Dual-antenna mode, add Slave satellite profile



7. Enter the satellite profile name, for example: **Dual Antenna Master**.
8. As VSAT modem profile select **Dual Antenna Master**.
9. Click **Apply**.
10. Go to **SETTINGS > Satellite profiles** and activate the satellite profile **Dual Antenna Master**.

The screenshot shows the 'Thrane & Thrane' web interface. At the top, there is a 'SIGNAL:' indicator with a full bar. Below it is a navigation menu with options like DASHBOARD, SETTINGS, Satellite profiles, VSAT modem profiles, Blocking zones, Network, E-mail setup, Reports, Dual antenna, SERVICE, and ADMINISTRATION. The main content area is titled 'SATELLITE PROFILES' and contains a table with columns for Name, Position, and actions (Edit, Delete, Activate). The 'Dual Antenna System' profile is highlighted, and its 'Activate' link is circled in red.

Name	Position	
ASTRA 1 K/R	19.2 E	<a href="#">Edit</a> / <a href="#">Re-activate</a>
STM 22W	auto	<a href="#">Edit</a> / <a href="#">Delete</a> / <a href="#">Activate</a>
Azi Cal	19.2 E	<a href="#">Edit</a> / <a href="#">Delete</a>
W7A beacon	7 E	<a href="#">Edit</a> / <a href="#">Delete</a> / <a href="#">Activate</a>
ComTech 625L	1 W	<a href="#">Edit</a> / <a href="#">Delete</a> / <a href="#">Activate</a>
Remote	auto	<a href="#">Edit</a> / <a href="#">Delete</a> / <a href="#">Activate</a>
Gilat	28.5 E	<a href="#">Edit</a> / <a href="#">Delete</a> / <a href="#">Activate</a>
Dual Antenna System	auto	<a href="#">Edit</a> / <a href="#">Delete</a> / <a href="#">Activate</a>
<a href="#">New entry</a>		

Figure 6-30: Dual-antenna mode, Activate

## Blocking zone setup

It is recommended to define the following 3 blocking zones in each SAILOR 900 VSAT system:

1. Actual blocking zones on the vessel (No TX)
2. Switching blocking zones (TX allowed).
3. Personnel safety zones (No TX)

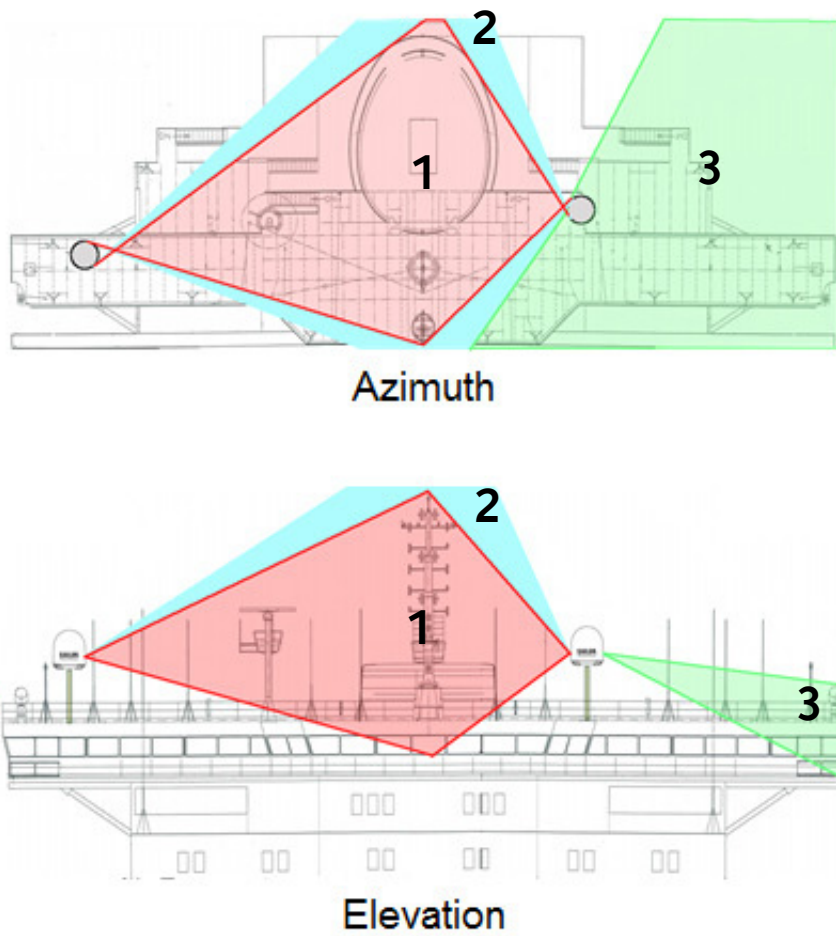

Figure 6-31: Dual-antenna mode, blocking zones — azimuth and elevation

For instructions how to set up blocking zones see *Setting up Blocking zones (RX and TX)* on page 6-24.

## Line up and commissioning

The SAILOR 900 VSAT antenna systems must be lined up and commissioned one by one. The lineup procedure is done for each antenna as it would have been done for a single antenna system. In order to be able to do the lineup for each antenna you must force the dual system to use one or the other antenna at a time. Do as follows:

1. Enter the web interface of the Master ACU, go to the page **SERVICE > Dual antenna mode**.

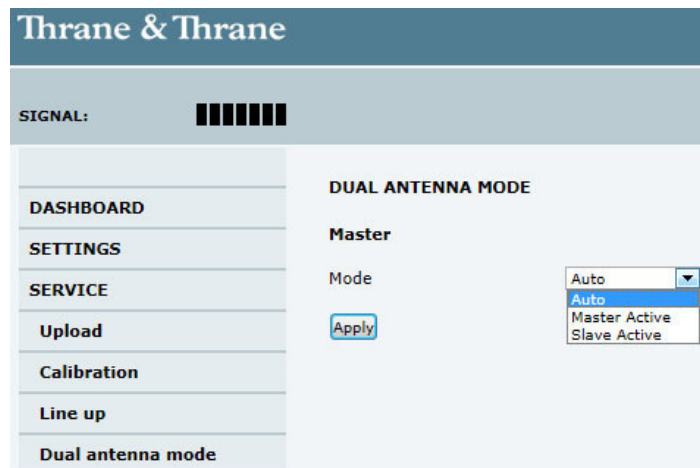

Figure 6-32: Dual-antenna mode, line up

2. Set the mode to either **Master active** or **Slave active** to force the system to use that antenna until it is changed again or the Master system is rebooted. After reboot the dual antenna mode will be set to Auto (default).

### 6.3.9 Upload

For uploading new software to the SAILOR 900 VSAT see *Software update* on page 8-4.

### 6.3.10 Administration

In this section of the web interface you can configure the following administrative settings:

- *Accessing the administration settings (user name, password)*
- *Setting up user permissions*
- *Importing and exporting a system configuration*
- *Resetting to factory default*

#### Accessing the administration settings (user name, password)

The Administration settings require an Administration user name and password. To log on as administrator, do as follows:

1. Select **ADMINISTRATION** from the left navigation pane.
2. Enter the Administration user name and password.

The default user name is **admin** and the default password is **1234**.

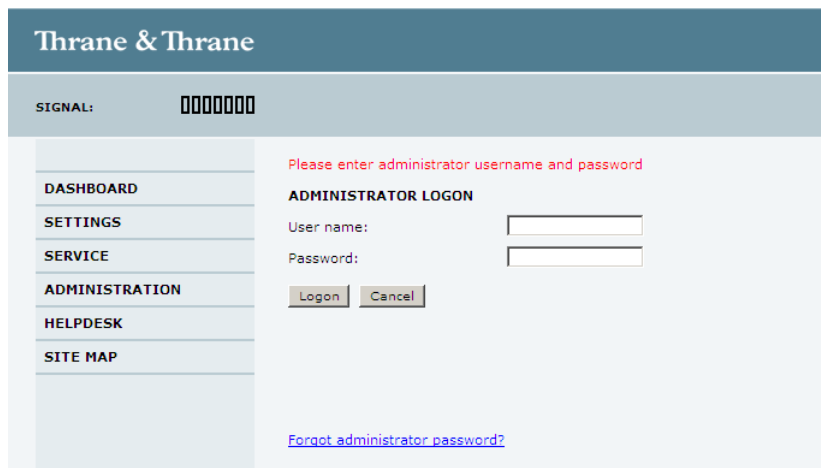

Figure 6-33: Web interface: Administration

If you have forgotten the administrator password, you can reset the password. For further information, see the next section.

3. Click **Logon**.

The Administration page is now updated to let you change the user name and password or log off Administration.

**To change the administrator password, do as follows:**

1. After entering the administrator user name and password in the **ADMINISTRATION** page, locate the section **Change administrator logon**.

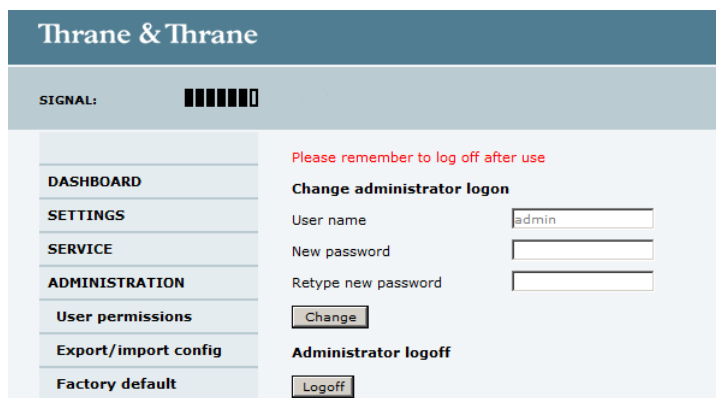

Figure 6-34: Web interface: Administration, change administrator logon and password

2. Type in the new password and retype it on the next line.
3. Click **Change**. At the next logon the new password is required.

**To reset the administrator password, do as follows:**

1. Contact your service partner for a reset code. Report the serial number of the ACU. You find it in the **Dashboard, ACU serial number**.

2. Click the link **Forgot administrator password?** at the bottom of the **ADMINISTRATOR LOGON** page (see Figure 6-33: *Web interface: Administration*).

The screenshot shows the Thrane & Thrane web interface. At the top, there is a header with the company name. Below it, a 'SIGNAL:' field is visible with a masked input. The main content area is titled 'RESET ADMINISTRATOR PASSWORD' and contains a 'Reset code:' input field with two buttons: 'Reset' and 'Cancel'. On the left side, there is a navigation menu with the following items: 'DASHBOARD', 'SETTINGS', 'SERVICE', and 'ADMINISTRATION'.

Figure 6-35: Web interface: ADMINISTRATION, Reset administrator password

3. Type in the reset code obtained from your service partner and click **Reset**.
4. Type in the user name **admin**, the default password **1234** and click **Logon**.

### Logging off administration

If you have not entered anything for 30 minutes under **ADMINISTRATION**, you are logged off automatically. To log off manually, click **Logoff** under administrator logoff in the **ADMINISTRATION** page.

### Setting up user permissions

You can manage user access to certain functions of the SAILOR 900 VSAT system. You can allow or deny users that are not administrators access to certain functions and make these pages read-only. This is useful if you want to protect the system against unintended changes or tampering of the system.

#### Important

Study this screen thoroughly and decide which areas of the SAILOR 900 VSAT system you want to give non-administrator users access to.

To set up the user permissions, do as follows:

1. From the left navigation pane, select **ADMINISTRATION > User permissions**.

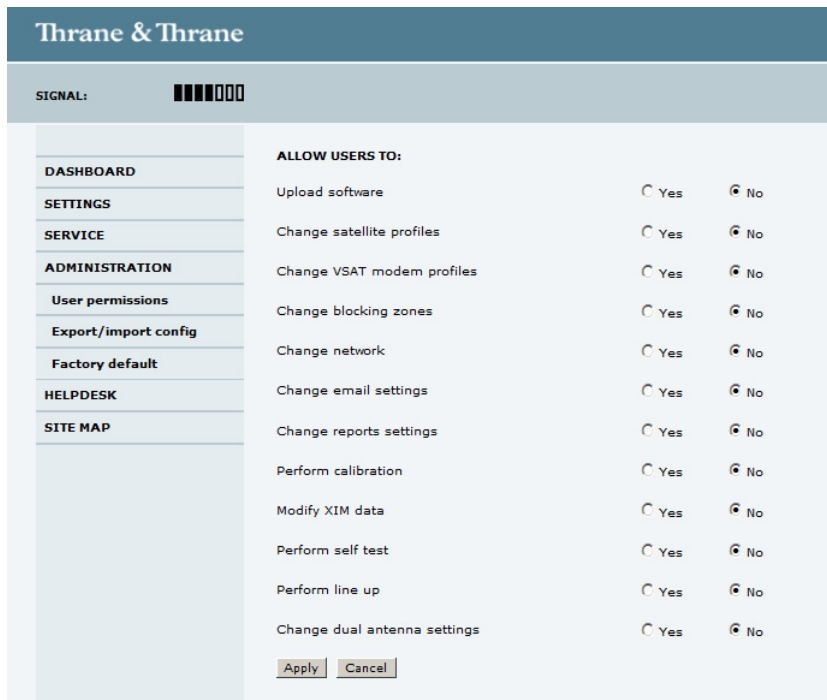

Figure 6-36: Web interface: ADMINISTRATION, User permissions

- For each item under **ALLOW USERS TO:** select
  - Yes** to allow access
  - No** to block access to the settings. Then the pages are read-only, changes cannot be made by non-administrator users.

**Change network:** Change IP configuration of the LAN connectors. For further information see *Configuring the LAN network* on page 6-26.

**Change email settings:** Change e-mail addresses for sending reports. For further information see *E-mail setup* on page 6-29.

**Modify XIM data:** Only used during service and maintenance.

- Click **Apply**.

The settings to which access is denied are now greyed out for the non-administrator user.

## Importing and exporting a system configuration

If you need to reuse a configuration in another SAILOR 900 VSAT system, you can save the current configuration to a file, which can then be loaded into another SAILOR 900 VSAT. You can also use this feature for backup purposes.

The configuration file contains all the settings you have entered during system setup: satellite profiles, modem profiles, LAN setup, blocking zones, etc.

To save a configuration to a file, do as follows:

- Select **ADMINISTRATION > Export/import config**.

2. Click the button **Export**. Follow the download instructions on the screen. You can use this configuration file for upload into another SAILOR 900 VSAT,

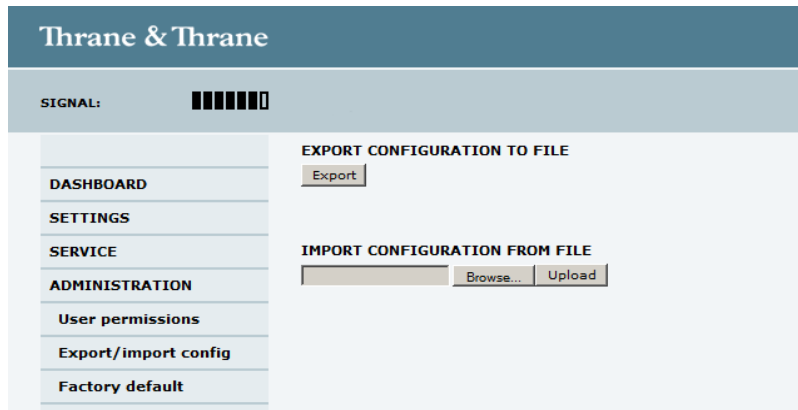

Figure 6-37: Web interface: Administration, Export/import configuration

To load a configuration from a file, do as follows:

1. Select **ADMINISTRATION > Export/import config**.
2. Click the button **Browse** and locate the configuration file (.cfg file) you want to upload. Then click the button **Open**.
3. In the web interface click the button **Upload**.

**To clone a system configuration, do as follows:**

1. Reset to factory default, see the following section for details.
2. Import a configuration from file, see section above.

## Resetting to factory default

When resetting SAILOR 900 VSAT to factory default, the following settings are deleted:

- All satellite profiles
- All VSAT modem profiles
- Blocking zones
- Heading settings
- Network setup
- User permissions
- ACU display: brightness setting

To reset to factory default settings, do as follows:

1. From the left navigation pane, select **ADMINISTRATION > Factory default**.



Figure 6-38: Web interface: ADMINISTRATION, Factory default

2. Click **Reset to factory default**.

**Note** | Calibration data for azimuth and cable calibration are not reset during factory default.



## 6.4 Keypad and menus of the ACU

### 6.4.1 ACU display and keypad

In the ACU display you can see the current state of the system. You can also see events (warnings, errors and information) and how the system has been configured. Use the keypad to navigate through the menu tree.

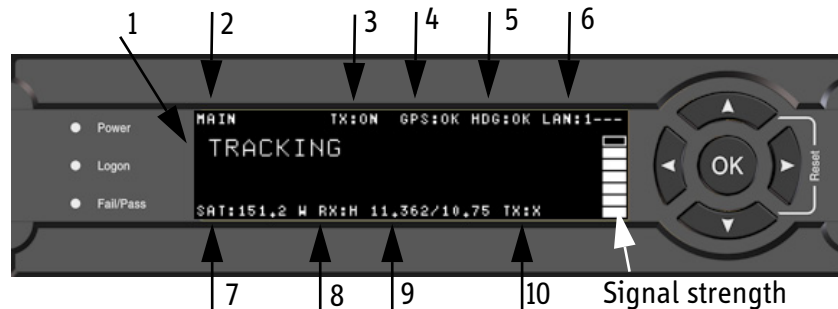

Figure 6-39: Display (example) and keypad of the ACU

1. Current status of the SAILOR 900 VSAT:  
**NOT READY** (Waiting for input from GNSS, e.g. GPS)  
**READY** (no satellite profile selected)  
**POINTING ANTENNA** (Locating the satellite)  
**ACQUIRING SIGNAL** (Acquiring the satellite signal)  
**TRACKING** (Tracks the current satellite)  
**BLOCKING ZONE** (Antenna is pointing into a blocking zone)
  2. Current menu.
  3. TX: Current transmission state, ON or OFF (off when in blocking zone).
  4. GPS: GPS signal is received from the GPS module, OK or —.
  5. HDG: Ship heading data received from the ship's gyro, OK or —.
  6. LAN: LAN connectors used, 1, 2, 3, 4, —.
  7. SAT: Satellite position of currently active satellite profile.
  8. RX: RX polarisation of currently active satellite profile. H (horizontal), V (vertical), L (left-hand) R (right-hand).
  9. RF tracking frequency in GHz and LNB LO Frequency.
  10. TX:X TX polarisation of currently active satellite profile. X (Cross polarisation) or Co (Co-pol).
- After 1 hour the display is dimmed to lowest intensity. Press any key to light up the display.

### 6.4.2 Navigating the menus

Use the keypad to navigate the menus.

- Press **OK** or **▶** to select a menu item.
- Use the arrow keys **▲** and **▼** to go through the menu items or enter a number, digit by digit.
- Use the arrow keys **◀** and **▶** to go through the settings and move from one digit to the next.
- Press **OK** to select a setting.
- Press **◀** again to move one level up. If applicable, confirm to store the new setting by pressing **OK**.

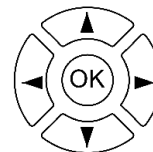

### 6.4.3 The menu tree

In the menu tree you can see how the system has been configured. You can also enter satellite information directly, if it is necessary to change the satellite information and you cannot use a connected PC and the web interface.

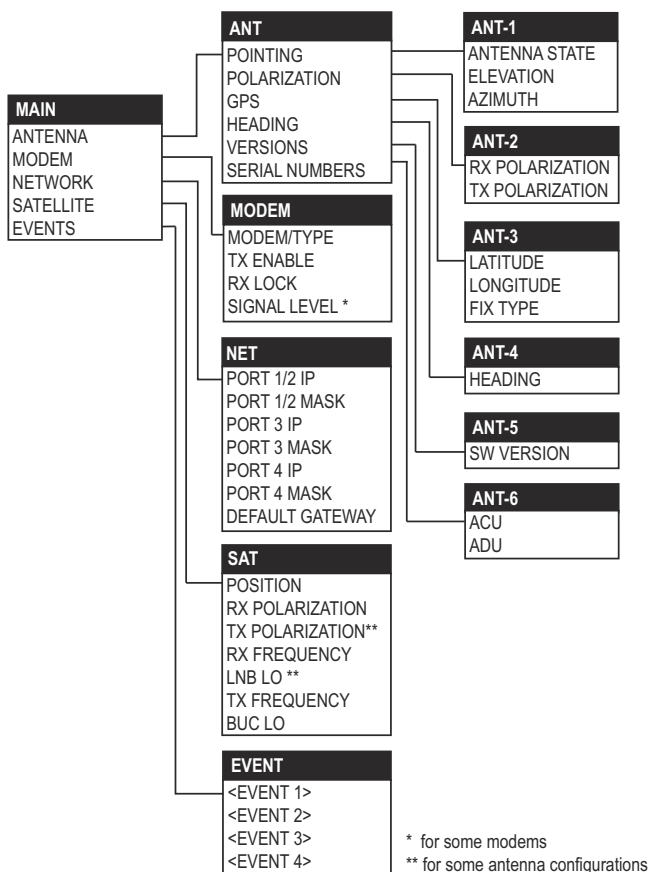

Figure 6-40: Antenna Control Unit, menu tree

## Top-level menu

Top-level menu	Description
MAIN	<p>View with current status of the SAILOR 900 VSAT. Example when logged on to the satellite:</p>  <p>TRACKING</p> <p>SAT:151.2 W RX:H 11.362/10.75 TX:X</p> <p>This view is displayed after a time out of 10 minutes. Press any key (except left arrow) to enter the menu at <b>MAIN</b>.</p> <p>New events are shown in this display. If an event is displayed, press <b>OK</b> to jump directly to the menu <b>EVENTS</b> for viewing the currently active events.</p>
ANTENNA	Shows the current ADU parameters, position, software version and serial numbers of the ADU and ACU.
MODEM	Selected VMU type and setup, including signal level.
NETWORK	Shows the IP addresses and netmasks of the LAN connectors of the ACU and the management mask.
SATELLITE	Current satellite information. This information is entered using the web interface.
EVENTS	View system events. Active events are shown as: X ACTIVE EVENTS in the <b>MAIN</b> display. Press <b>OK</b> to update the list.

Table 6-13: Top-level menus of the ACU

## Menu descriptions

ANTENNA menu	Description
POINTING	<p>ANTENNA STATE: Current state of the antenna, e.g. TRACKING</p> <p>ELEVATION: Current elevation angle of the antenna</p> <p>AZIMUTH: Current azimuth of the antenna, with reference to North</p>
POLARISATION	<p>RX POLARISATION: HORIZONTAL or VERTICAL, read from connected VSAT modem.</p> <p>TX POLARIZATION: X-POL or Co-POL, read from connected VSAT modem.</p>

Table 6-14: ANTENNA menu of the ACU

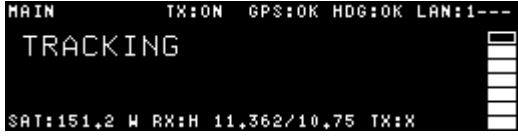
ANTENNA menu	Description
GPS	LATITUDE: current latitude, read from GPS module. LONGITUDE: current longitude, read from GPS module. FIX TYPE: 2D or 3D
HEADING	Ship's heading in degrees with reference to North, provided by the ship's gyro.
VERSIONS	Current software version.
SERIAL NUMBERS	ACU: ACU serial number; ADU: Serial number of the antenna

Table 6-14: ANTENNA menu of the ACU (Continued)

MODEM menu	Description
MODEM TYPE	Connected modem type.
TX ENABLE	On or off, information delivered by the connected VSAT modem.
RX LOCK	On or off, information delivered by the connected VSAT modem.
SIGNAL LEVEL	Current input signal level from VSAT modem. iDirect openAMIP modem: (PWR) 0-500, delivered by the connected modem. For values <250 the antenna searches after a new signal. Other modem: Signal level in dB.

Table 6-15: MODEM menu of the ACU

NETWORK menu	Description
PORT 1/2 IP	Current IP address for LAN 1 and LAN 2.
MASK 1/2	Current netmask for LAN 1 and LAN 2.
PORT 3 IP	(LAN 3) Current IP address of the SAILOR 900 VSAT web interface (default: 192.168.0.1).
MASK 3	(LAN 3) Current netmask of the SAILOR 900 VSAT web interface (default: 255.255.255.0).
PORT 4 IP	Current IP address for LAN 4.
MASK 4	Current netmask for LAN 4.

Table 6-16: NETWORK menu of the ACU

NETWORK menu	Description
DEFAULT GATEWAY	Current default gateway.

Table 6-16: NETWORK menu of the ACU (Continued)

SATELLITE menu	Description
POSITION	Position of the current satellite.
RX POLARISATION	HORIZONATL, VERTICAL.
TX POLARIZATION	X-polarisation or Co-polarisation, auto-selected by VSAT modem
RX FREQUENCY	Ku band receiving frequency of the active satellite, auto-selected by VSAT modem.
LNB LO	Auto selected by VSAT modem.
TX FREQUENCY	Transmission frequency, auto-selected by VSAT modem
BUC LO	12.8 GHz, system parameter

Table 6-17: SATELLITE menu of the ACU

EVENT menu	Description
<EVENT>	<p>In this menu all active events are listed. Use ▼ and ▲ to go through the active events.</p> <p>Events can be of the type WARNING or ERROR.</p> <p>If a new event occurs or there is a change in the event list while you are in the <b>EVENTS</b> menu, a * is shown in the upper left corner of the display, next to the menu name. Press <b>OK</b> to update the EVENTS list, the * will be removed.</p> <p>A &gt; means the event text is longer than the display. Press to &gt; to see the remaining text.</p>

Table 6-18: EVENTS menu of the ACU

**Example:** **EVENT 1/4\***: This is the first event out of a list of 4 and there has been a change in the list. EVENT 1/4 will always be shown, the \* indicates that there has been a change.

## 6.4.4 Adjusting brightness of the display

To adjust the brightness do the following:

1. Press and hold **OK** for a short moment until BRIGHTNESS XXX% is displayed (XXX is the current brightness value).
2. Hold OK pressed + press ▲ for lighter or ▼ for darker display.
3. Release OK to leave the brightness menu.

## 6.4.5 Resetting the system

To reset the system do the following:

1. Press and hold ▲ and ▼ until the ACU display shuts down and the ACU reboots.



Figure 6-41: Reset the system

2. Wait until the system has rebooted and is operational again. The last active satellite profile will be used.

## 6.5 SNMP support

The SAILOR 900 VSAT supports SNMP v2 requests to retrieve configuration and present settings. SNMP is always enabled on all Ethernet interfaces. The SNMP community string is **public**.

The SAILOR 900 VSAT offers via SNMP most of the data that are available from the DASHBOARD web pages. Detailed documentation about supported OIDs can be found in the SAILOR 900 VSAT MIB file.

The MIB entries are grouped as shown below:

- System configuration
- Navigation coordinates
- Antenna pointing
- Dashboard and profile
- Tracking receiver

**Note**

All SNMP values are of a nature which does not need to be polled more often than once a minute. Polling SNMP values more frequently will impact the performance of the ACU.

You can acquire the ACU MIB file in two ways:

1. Download the ACU MIB from Cobham eSupport web site.
2. Download the ACU MIB file directly from your ACU:

`http://acu-ip-address/mibs/mib-file-name`

e.g. `http://192.168.0.1/mibs/thrane_tt7090_all_SMIv2.mib`





# Installation check

Now that you have installed the system, you can test it to verify it is ready for customer delivery. Follow the check lists below to test the system for proper operation.

- *Installation check list: Antenna*
- *Installation check list: ACU, connectors and wiring*
- *Installation check list: Functional test in harbor*

## 7.1 Installation check list: Antenna

Step	Task	Further information	Done
1.	Check that the antenna is free of obstructions.	See <i>Obstructions (ADU shadowing)</i> on page 3-4.	
2.	Make sure there is sufficient space for access through the service hatch.	See <i>Installing the ADU</i> on page 3-19.	
3.	Make sure to maintain the vertical orientation of the ADU center line.		
4.	Check that the ADU is installed where vibrations are limited to a minimum.		
5.	Check that you programmed the blocking zones correctly.	See <i>Blocking zones — azimuth and elevation</i> on page 3-5 and <i>Setting up Blocking zones (RX and TX)</i> on page 6-24	
6.	Make sure that the safety distance for radiation hazard of 30 metres is kept.	See <i>Safe access to the ADU: Radiation hazard</i> on page 3-6	
7.	Check that the mounting height of the antenna is in accordance with the ship's min. roll period.	See <i>Ship motion and offset from the ship's motion centre</i> on page 3-7.	

Table 7-1: Installation check list: Antenna

Step	Task	Further information	Done
8.	Make sure that the requirements for mast foundation and height, including flatness, gusset plates and distance from welding seams are met.	See <i>ADU mast design: Foundation and height</i> on page 3-8.	
9.	Make sure that the distances to radar, Inmarsat systems, GPS receivers and other transmitters are as required.	See <i>Interference</i> on page 3-13.	
10.	Make sure that the drain tube is open and risk for water intrusion is at a minimum.	See <i>Other precautions</i> on page 3-17.	
11.	Check that the ADU is grounded correctly, using the mounting bolts.	See <i>Grounding the ADU</i> on page 3-23 and <i>Grounding and RF protection</i> on page F-1.	

Table 7-1: Installation check list: Antenna (Continued)

## 7.2 Installation check list: ACU, connectors and wiring

Step	Task	Verification and further information	Done
1.	Check that the ACU is grounded correctly, using the mounting bolts and washers.	See <i>Grounding the ACU</i> on page 3-25 and <i>Grounding and RF protection</i> on page F-1.	
2.	Make sure you strain relieved the cables.	See <i>Installing the 19" rack version of the ACU</i> on page 3-25.	
3.	Make sure that the VSAT modem is mounted close to the ACU.	See <i>General mounting considerations — VMU</i> on page 3-26.	
4.	Check that the ADU antenna N-connector is properly connected with the 50 Ohm RF cable.	Visual inspection of the cover plate at the bottom of the ADU.	
5.	Check that the ACU antenna N-connector is properly connected with the 50 ohm RF cable.	Visual inspection of the connector panel of the ACU.	
6.	Check that the ACU's <b>Rx Out</b> is connected to the VSAT modem's Rx in using the included 1 m F-F 75 ohm cable.	Visual inspection of the connector panel of the ACU and the VSAT modem.	
7.	Check that the ACU's <b>Tx In</b> is connected to the VSAT modem's Tx out using the included 1 m F-F 75 ohm cable.	Visual inspection of the connector panel of the ACU and the VSAT modem.	

Table 7-2: Installation check list: ACU, connectors and wiring

Step	Task	Verification and further information	Done
8.	<p>Check connection of the VSAT modem:</p> <p><b>COMTECH only!</b> Check that the ACU RS-232 port is connected to the Remote Control port and Alarm port of the VMU using the serial cable (specifications in <i>Modem Cable COMTECH Serial &amp; RSSI TT7016A</i> on page B-2).</p> <p><b>iDirect iNFINITI Series/ Evolution only!</b> Check that the ACU RS-232 port is connected to the Console port of the VMU using the included serial cable.</p> <p><b>iDirect iNFINITY Series only!</b> Check that the ACU LAN port 1 is connected to the LAN B of the VMU using the included CAT5 Ethernet cable.</p> <p><b>iDirect Evolution only!</b> Check that the ACU LAN port 1 is connected to the LAN of the VMU using the included CAT5 Ethernet cable.</p> <p><b>STM SatLink 2900:</b> Check that the ACU LAN port 1 is connected to the LAN of the VMU using the included CAT5 Ethernet cable.</p> <p><b>Gilat SkyEdge II VSAT modem:</b> Check that the ACU RS-232 port is connected to the SERIAL port of the VMU using the included serial cable.</p>	<p>Visual inspection of the connector panel of the ACU and the VSAT modem. See also:</p> <p><i>Connecting a COMTECH 570 L or 625 Satellite Modem</i> on page 4-8</p> <p><i>Connecting an iNFINITI® Series Satellite Router</i> on page 4-7</p> <p><i>Connecting an Evolution® Satellite Router</i> on page 4-8</p> <p><i>Connecting a COMTECH 570 L or 625 Satellite Modem</i> on page 4-8</p> <p><i>Connecting a Gilat SkyEdge II VSAT modem</i> on page 4-10</p>	
9.	<p>Check that the ADU's NMEA 0183 connector is connected to the NMEA 0183 bus of the vessel using the included multi-connector</p>	<p>Visual inspection of the connector panel of the ACU connector.</p>	
10.	<p>Measure that the power has the correct polarity in the power connector, before connecting it to the ACU power input. (<math>V_{in+}</math>: left, <math>V_{in-}</math>: right).</p>	<p>Use a volt meter. See Table 4-1: <i>DC Input plug, outline and pin assignment</i> on page 4-2.</p>	

Table 7-2: Installation check list: ACU, connectors and wiring (Continued)

## 7.3 Installation check list: Functional test in harbor

Step	Task	Further information	Done
1.	Check that the antenna is tracking the satellite	The logon LED in the ACU display must be steady green and the display shows: <b>TRACKING</b> . In the web interface check: <b>DASHBOARD:</b> <b>System status: Tracking</b>	
2	Check that the VMU is in lock and ready for Tx.	In the web interface check: DASHBOARD > VSAT MODEM > Signal level and RX frequency show values.	
3	Connect a user PC LAN (not the service PC) to the Internet LAN connector, either on the LAN port 2 of the ACU (only X5 VSAT modem) or to the User LAN connector on the VMU.	Check the VSAT modem documentation for details.	
2.	Open a DOS window and type: ping 4.2.2.2.	Check that you get a response.	
3.	Open a web browser and browse to www.google.com.	Check that the web page is downloaded.	
4.	If step 4 is successful and step 5 is not then it seems like the DNS is not configured correctly.	Check with the VSAT modem documentation how the DNS server must be set up, "Obtain DNS server address automatically" or enter specific DNS server addresses.	

Table 7-3: Installation check list: Functional test in harbour



# Service

In this chapter you find the following sections:

- *Getting support: Helpdesk*
- *Software update*
- *Status signalling with LEDs and status messages*
- *Removal and replacement of the ACU*
- *Removal and replacement of ADU modules*
- *Troubleshooting*

## 8.1 Getting support: Helpdesk

If this manual does not provide the remedies to solve your problem, contact your service provider.

### 8.1.1 Help desk and diagnostic report

During the installation you can enter the support contact for this installation.

To access the Help desk, select **HELPDESK** from the left navigation pane.

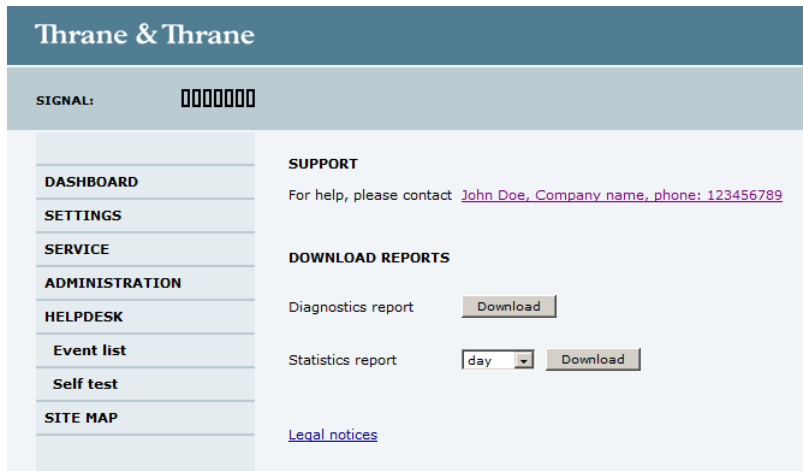

Figure 8-1: Web interface: HELPDESK

Click the link, enter support contact information and click **Apply**. Clicking the link Legal notice provides licence text for the source code of the parts of the SAILOR 900 VSAT software that falls under free and open source software.

If you need help **with ACU or ADU related issues** call your service provider.

### Download of a diagnostic report or a statistics report

You can download a diagnostic report. This report contains information relevant for the service personnel during troubleshooting. To generate a diagnostics report click **Download**.

You can download a statistics report. This report contains information relevant for the service personnel during troubleshooting.

To generate a statistics report select the period for the statistics from the drop down list and click **Download**.

You can also configure the system to send diagnostic reports at defined time intervals. For further details on this see *Sending a diagnostics report* on page 6-33.

### Event list

When an event is registered, the web interface shows an event icon  in the icon bar as long as the event is active. The ACU display shows also active events. To view the event list with active events, click the event icon from the icon bar at the top of the web interface, or select **HELPDESK > Event list** from the left navigation pane.



The screenshot shows the Thrane & Thrane web interface. At the top, there is a header with the company name and a signal strength indicator. Below the header, there is a navigation menu on the left with options: DASHBOARD, SETTINGS, SERVICE, ADMINISTRATION, HELPDESK, Event list, Self test, and SITE MAP. The main content area is titled 'ACTIVE EVENTS' and contains a table with columns: Time UTC, ID, Unit, Severity, and Text. There are two rows of event data. Below the table, there is a section for 'NOTIFICATIONS' which states 'Notification list empty'.

Time UTC	ID	Unit	Severity	Text
13:06:32 10 Sep 2012	09010-0	Terminal	ERROR	KDM link/SW version (00000003)
13:06:27 10 Sep 2012	08108-0	Terminal	ERROR	TX Power Detector calibration (00000000)

Figure 8-2: Web interface: HELPDESK, Event list

The **Event list** page shows a detailed list of active events and notifications including the time of the first occurrence, ID and severity of the event message, and a short text describing the error.

Active events are cleared from the event list when the error is cleared. They are moved to the section **Notifications** and are displayed for 24 hours.

All entries in the section **Notifications** are cleared automatically after 24 hours and after restart of the system.

For a list of all events with description, error code (ID), explanation and remedy see *List of events with explanation and remedy* on page C-1.

## Self test

You can start a self test of the SAILOR 900 VSAT ADU and ACU.

1. Click **Self test** in the **HELPDESK** page.
2. Click the menu item **Self test**.

### Important

Warning! The SAILOR 900 VSAT will reboot to perform the self test. Rebooting the ACU will terminate all existing connections.

## Reset to factory defaults

You can reset the SAILOR 900 VSAT ADU and ACU to factory defaults. See *Resetting to factory default* on page 6-43.

### Important

Warning! Reset to factory default will delete all settings, including satellite and VSAT modem profiles, blocking zones, network setup, user permissions and ACU display brightness settings.

## 8.2 Software update

### 8.2.1 Hardware and software requirements

The following items are required before the software can be updated:

- One computer with a standard Ethernet port available.
- A standard Internet browser.
- 1024×768 pixels or higher display resolution. The program is best viewed using small fonts.
- One straight LAN cable.
- The file containing the new software.

### 8.2.2 Software update (ADU and ACU)

**Note** Software update should only be done by qualified service personnel.

You can update the software in two ways:

- *Software update using the TMA (Thrane Management Application)*
- *Software update using the web interface of the ACU*

#### Software update using the TMA (Thrane Management Application)

1. Download the TMA from Cobham eSupport web site (Self-Service Center, SSC. You find the SSC in the Service and Support section, 24-7 Service). Make sure to use version 1.03 or higher.
2. Make sure that your PC is on the same network as the SAILOR 900 VSAT.
3. Power up the SAILOR 900 VSAT system, i.e. switch on the ACU. Wait until the SAILOR logo has disappeared from the ACU display.
4. Connect a PC to LAN interface 3 (Service port, standard Ethernet) or the front LAN connector of the ACU.

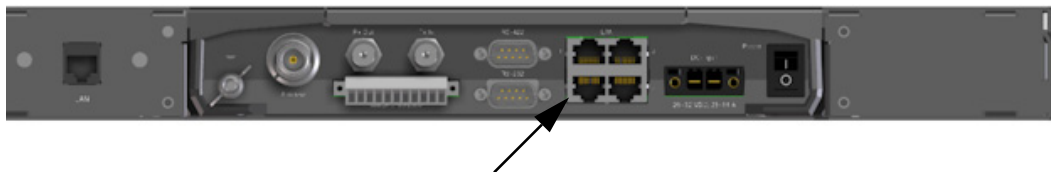

Figure 8-3: LAN connector used for software update (TMA)

5. Start the TMA. The SAILOR 900 VSAT is automatically detected. Click the icon for the SAILOR 900 VSAT to display the following screen:

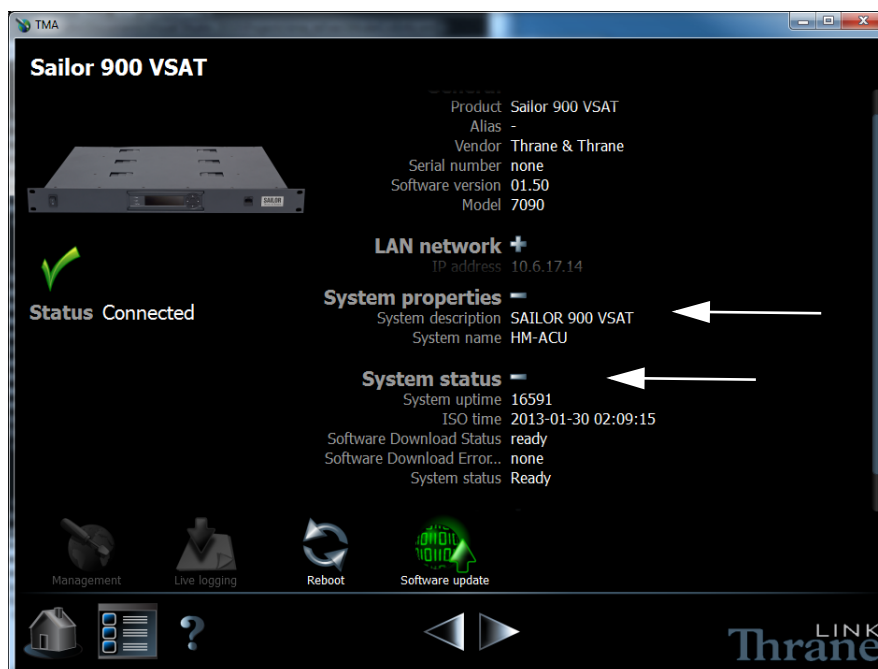

Figure 8-4: SAILOR 900 VSAT connected: Software update with the TMA

The **Software Download Status** must show **Ready**.

6. The icon **Software update** pulsates yellow when a new software version is detected for the SAILOR 900 VSAT.  
The TMA searches all devices connected via USB for new software. You can add an additional search path. To do so press the icon **Option** on the software update screen and select **Search for software**. A dialog box is displayed and you can select a directory.
7. To start the software update click the icon **Software update** and select **Update**. The current and the new software version numbers are displayed.  
You can also select a specific software version. To do so press the icon **Option** on the software update screen and select **Select software**. A list of available software versions is displayed. Select one and click the button **Update**.

## Software update using the web interface of the ACU

1. Power up the SAILOR 900 VSAT system, i.e. switch on the ACU. Wait until the SAILOR logo has disappeared from the ACU display.
2. Connect a PC to LAN interface 3 (Service port, standard Ethernet) or the front LAN connector of the ACU.



Figure 8-5: LAN connector used for software update (web interface)

3. Open your Internet browser and enter the IP address of the ACU. The IP address is **http://192.168.0.1** (default). For further details on network setup see *Configuring the LAN network* on page 6-26.
4. The web interface opens directly with the **DASHBOARD** page.
5. Click **SERVICE** from the left navigation pane. The **Upload** page is displayed.

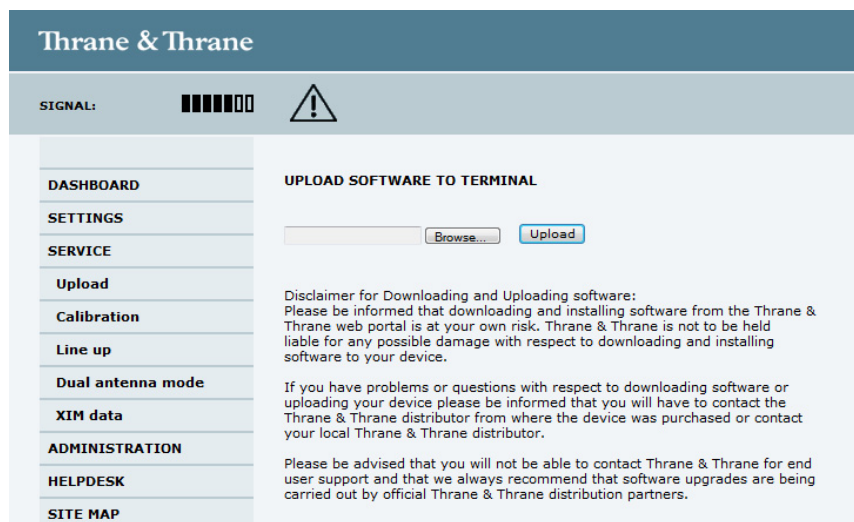

Figure 8-6: Software update with the web interface

6. Click **Browse...** and locate the new software file.
7. Click **Upload**.  
Note that the upload procedure takes a couple of minutes. When done, the ACU automatically restarts with the new software version.

### Important

Do not browse away from the upload page. This will terminate the upload process. Wait for the browser to reload automatically.

The start-up procedure after a software upload takes longer than the usual start-up time, as the software in the ADU must also be updated. The ACU display shows: **ADU SW UPLOAD**.

## If software upload fails - how to recover

To recover from a failed software upload, turn off the ACU and turn it on again. Then repeat the upload procedure as described in *Software update* on page 8-4.

### 8.2.3 Verifying the software update

1. The software version can be viewed in the **DASHBOARD** window of the web interface.
2. After completing the software update procedure, the ACU will perform a POST (Power On Self Test).
3. When the POST has finished, the green Pass/Fail LED on the front of the ACU must become steadily green. Verify that the Pass/Fail LED is not red nor flashing orange once every 2 seconds. Wait until the Pass/Fail LED is green.
4. Verify that the software update has been completed successfully. You find the software version number in the **DASHBOARD** window of the web interface.

The screenshot shows the Thrane & Thrane web interface dashboard. The top navigation bar includes: SIGNAL: [Signal strength indicator], DASHBOARD, SETTINGS, SERVICE, ADMINISTRATION, HELPDESK, and SITE MAP. The main content area is divided into several sections:

- SAILOR 900 VSAT**:
 

System status	Tracking	ACU part name	TT-7016A
GPS position	55°48' N, 12°31' E	ADU part name	TT-7009A
Vessel heading	0°	ACU serial number	ACU_4
Satellite profile	ROSS	ADU serial number	12345678
Satellite position	37.5°W	Software version	1.41 build
- POINTING**:
 

Azimuth relative	234.4°
Elevation relative	12.4°
Polarisation skew	28.0°
- TX**:
 

BUC TX	On
BUC output power	[Power indicator]
- VSAT MODEM**:
 

Model	COMTECH 570L and ROSS
Signal level	8 dB
RX IF frequency	1770.900000 MHz
TX IF frequency	1316.580000 MHz
TX allowed	On

A red circle highlights the 'Software version' field in the SAILOR 900 VSAT section, which displays '1.41 build'. A 'Refresh' button is located at the bottom of the dashboard.

Figure 8-7: Verifying software update

## 8.3 Status signalling with LEDs and status messages

### Built-In Test Equipment

The ADU and the ACU have a Built-In Test Equipment (BITE) function in order to make fault diagnostics easy during service and installation. The BITE test is performed during:

- Power On Self Test (POST), which is automatically performed each time the system is powered on.
- Person Activated Self Test (PAST), which is initiated by starting a self test in the web interface **HELPDESK > Self test**.

For details on error messages after a POST or a self test see *Event list* on page 8-2.

### Means of signalling

The SAILOR 900 VSAT provides various methods for signalling the system status. **LEDs** on the front panel of the ACU are used to signal:

- Power on/off
- Logon
- Fail/Pass

The built-in web interface of the ACU shows any events (BITE error codes) with a short message describing each error. This is also displayed in the ACU.

In an error situation, one of the following system status messages may be shown:

- ACU POST error
- ADU POST error
- SAFE MODE (plus information about the specific error, see *System messages* on page G-1).

### 8.3.1 LEDs of the ADU modules

Each ADU module has a Power and a Service LED.

LED	Behavior	Description
Power	Steady green	Power supply OK
	Off	No power
Service	Steady green	Module ok, application running.
	Flashing green	Waiting for upload
	Flashing red/green	Uploading application
	Steady red	Module error or loading error

Table 8-1: LEDs of the ADU modules

For a list of modules see *Removal and replacement of ADU modules* on page 8-11.

### 8.3.2 LEDs in the ACU

The ACU has 3 LEDs: Power, Logon and Fail/Pass LED.



Figure 8-8: LEDs on the ACU

LED	Behavior	Description
Power	Steady green	Power supply OK
	Steady red	Power supply failure
	Off	No power
Logon	Flashing green	Current status is displayed: <ul style="list-style-type: none"> <li>• Searching satellite</li> <li>• Identifying satellite</li> <li>• Carrier lock &amp; TX enabled from modem</li> </ul>
	Steady green	Satellite link established
	Off	No satellite link acquired

Table 8-2: LEDs on the ACU

LED	Behavior	Description
Fail/Pass LED	Steady red	A fault which prevents operation is present in the system (ACU, ADU, MODEM).
	Flashing green	A Power On Self Test (POST) or Person Activated Self Test (PAST) in progress. The current status is displayed.
	Flashing red	Active BITE failure or warning. The event is shown in the ACU display.
	Steady green	No faults.

Table 8-2: LEDs on the ACU (Continued)

## 8.4 Removal and replacement of the ACU

There are no parts in the ACU that you can remove or replace. Contact your Cobham SATCOM service partner for further repair or replacement.



Figure 8-9: Removal and replacement of the ACU 19" rack



## 8.5 Removal and replacement of ADU modules

All replacement of modules must be carried out by a Cobham SATCOM service partner. The figure below shows the modules and their position. Some modules are equipped with LEDs for status information and troubleshooting.

For instructions on how to open and remove the service hatch see *Opening and removing the service hatch* on page 3-22.

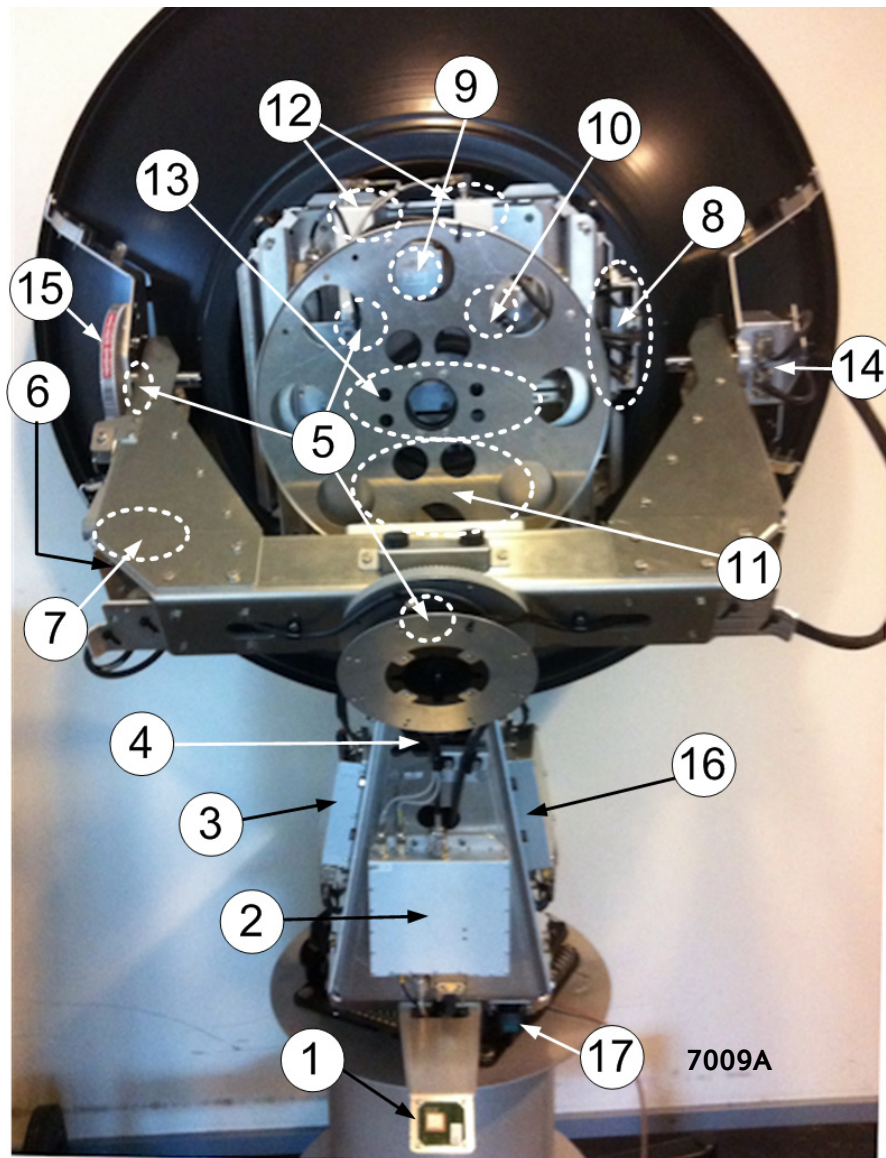

Figure 8-10: ADU modules and motor stop switch

1. GPS module.
2. VSAT Interface Module (VIM).
3. DC-Motor Driver Module for cross elevation (DDM).
4. Cross elevation motor and encoder.

5. Zero Reference Module (x4, 3 in the previous figure, 1 in the next figure) (ZRM) (not visible on photo).
6. DC-Motor Driver Module for elevation (on the bottom side) (DDM).
7. Elevation motor and encoder (not visible on photo).
8. Polarisation Motor Module (PMM).
9. Polarisation motor.
10. Polarisation encoder (not visible on photo).
11. Block Up Converter (BUC). (behind cable screen, not visible on photo)
12. Low Noise Block down converter (x2) (LNB).
13. Ortho Mode Transducer (OMT). (behind cable screen, not visible on photo)
14. Inertial Sensor Module (ISM).
15. Elevation locking pin to lock the antenna dish in a fixed position (for safety during service) (not visible on photo).
16. Pedestal Control Module (PCM).
17. Service switch.  
In switch-off position the DC Motor Driver modules (DDM), the Polarisation Motor Module (PMM) and the BUC are turned off for safe conditions during service and repair. The switch must be in on position for normal ADU operation.

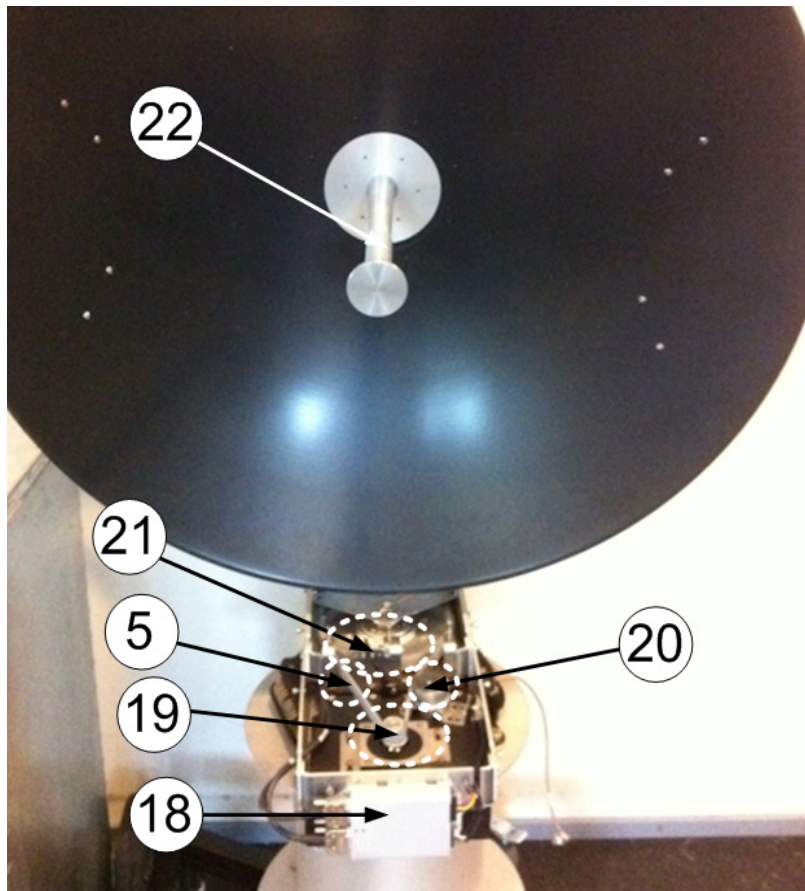

Figure 8-11: Above Deck Unit modules (continued)

18.DC-Motor Driver Module for Azimuth (DDM).

19.Azimuth motor.

20.Azimuth encoder.

21.Rotary joint.

22.Feed horn.

Before contacting your service partner check the LEDs on all modules (VIM, DDMs, PCM, PMM and ISM). See *LEDs of the ADU modules* on page 8-9 and *LEDs in the ACU* on page 8-9.

## 8.6 Troubleshooting

### 8.6.1 Overview

This section describes an initial check of the primary functions of the SAILOR 900 VSAT system, and provides some guidelines for troubleshooting, if one of the checks should fail.

Generally, if a fault occurs without any obvious reason, it is always recommended to observe the LEDs and the ACU display showing the active events. Possible failure states are shown in the web interface and the display of the ACU:

- SAFE MODE (e.g. hardware error, missing communication link between the ADU and ACU, excessive ship motion)
- XIM error (after exchange of modules)
- ADU POST error (hardware error)
- ACU POST error (hardware error)

For information on the function of the LEDs, see *Status signalling with LEDs and status messages* on page 8-8.

For a list of all the error messages and warnings, see *Event messages – overview* on page G-1.

### 8.6.2 Event list for troubleshooting

You can use the event list for troubleshooting. It is described in detail at *Help desk and diagnostic report* on page 8-2.

You can download the event list as part of a diagnostic report.

### 8.6.3 Diagnostic report for troubleshooting

You can generate a diagnostic report containing results from the POST, all events and system log information since the last reset to factory default. For more information see *Sending a diagnostics report* on page 6-33.

# Appendices



# Technical specifications

## A.1 SAILOR 900 VSAT system components

### A.1.1 General specifications

Item	Specification
Frequency band	Ku-band (VSAT)
Rx	10.70 to 12.75 GHz
Tx	13.75 to 14.50 GHz (extended)
Reflector size	103 cm (40 inch)
Certification (approval)	Compliant with CE (Maritime), ETSI EN 302 340, CEI/IEC 60950-1, CEI/IEC 60945, CEI/IEC 60950-22
ADU cable type (ACU to ADU)	Single 50 Ohm coax cable for Rx, Tx, ACU-ADU modem and power
ADU cable connector at the ADU	Female N-Connector (50 Ohm)
ADU cable connector at the ACU	Female N-Connector (50 Ohm)
System power supply range	20–32 VDC (Start up voltage: 22 VDC guaranteed)
Total system power consumption	370 W peak, 175 W typical (up to 8 W BUC)

Table A-1: General specifications

## A.1.2 ADU

Item	Specification
Dimensions (overall)	Diameter x Height: Ø 130 cm (51.3 inch) x H 150 cm (58.9 inch)
Weight	130 kg (287 lbs)
Antenna type, pedestal	3-axis (plus skew) stabilised tracking ADU with integrated GPS
Antenna type, reflector system	Reflector/sub-reflector, ring focus
Transmit Gain	41.4 dBi typ. @ 14.25 GHz (excluding radome)
Receive Gain	40.1 dBi typ. @ 11.70 GHz (excluding radome)
System G/T	19.9 dB/K typ. @ 11.70 GHz, at $\geq 30^\circ$ elevation and clear sky (including radome)
BUC output power	8 W
EIRP	$\geq 49$ dBW (including radome)
LNB	2 units 4-band LNBs (band selection by ACU)
Tracking Receiver	Internal "all band/modulation type" and VSAT modem RSSI
Polarisation	Linear Cross or Co-Pol (selected by ACU)
Elevation Range	$-25^\circ$ to $+125^\circ$
Azimuth Range	Unlimited (Rotary Joint)
Ship motion, angular	Roll $\pm 30^\circ$ , Pitch $\pm 15^\circ$ , Yaw $\pm 10^\circ$
Ship, turning rate and acceleration	$15^\circ/s$ and $15^\circ/s^2$
ADU motion, linear	Linear accelerations $\pm 2.5$ g max any direction

Table A-2: Technical specifications for the Above Deck Unit



Item	Specification
Satellite acquisition	Automatic - w. Gyro/GPS compass input
Vibration, operational	Sine: IEC 945 (8.7.2), DNV A, MIL-STD-167-1 (5.1.3.3.5). Random: Maritime
Vibration, survival	Sine: IEC 945 (8.7.2) dwell, MIL-STD-167-1 (5.1.3.3.5) dwell. Random: Maritime survival.
Shock	MIL-STD-810F 516.5 (Proc. II)
Temperature (ambient)	Operational: -25° C to 55° C Storage: -40° C to 85° C
Humidity	100%, condensing
Rain (IP class)	IEC 945 Exposed (IPX6)
Wind resistance	Operational: 80 kt. Survival: 110 kt.
Ice	Survival: 25 mm (1 inch)
Solar radiation	1120 W/m <sup>2</sup> to MIL-STD-810F 505.4
Compass safe distance	1 m to IEC 945
Maintenance, scheduled	None
Maintenance, unscheduled	All electronic, electromechanical modules and belts can be replaced through the service hatch.
Built-in tests	Power On Self Test (POST) Person Activated Self Test (PAST) Continuous Monitoring (CM) with error log
Power OFF	Automatic safe mode
Input power	Powered by ACU

Table A-2: Technical specifications for the Above Deck Unit (Continued)

### A.1.3 ACU

Item	Specification
Dimensions, rack mount	1 U, 19 inch
H x W x D	4.4 x 48 x 33 cm (1.75 x 19 x 13 inch)
Weight, rack mount	4.5 kg (10 lbs)
Ambient temperature	Operational: -25°C to +55°C Storage: -40°C to +85°C
Humidity	IEC 945 protected, 95% (non-condensing)
IP class	IP31
Compass safe distance	1 m to IEC 945
Interfaces	1 x N-Connector for antenna RF Cable (50 Ohm) w. automatic cable loss compensation 2 x F-Connectors (75 Ohm) for Rx/Tx to VSAT modem 4 x Ethernet 1 x RS-422 data (VSAT modem control) 1 x RS-232 data (VSAT modem control) 1 x NMEA 2000 (CAN bus) and NMEA 0183 (RS-422) for Gyro/GPS compass input 1 x DC power input 1 x Grounding bolt
Input power	See <i>System power supply range</i> and <i>Total system power consumption</i> on page A-1.
Modem interface (control)	iDirect openAMIP protocol & custom protocol
Man Machine Interface (MMI)	OLED (red) display, 5 push buttons, 3 discrete indicator LEDs and ON/OFF switch
No transmit zones	Programmable

Table A-3: Technical specifications for the ACU

## A.1.4 Supported VSAT modems

Item	Specification
VSAT modems supported	iDirect iINFINITI (Serial) iDirect iINFINITI (OpenAMIP) iDirect Evolution (Serial) iDirect Evolution (OpenAMIP) COMTECH CDM 570L COMTECH CDM 625L COMTECH 570L and ROSS STM SatLink 2900 Gilat SkyEdge II Inmarsat G5 For a list of supported VSAT modems see also the SAILOR 900 VSAT data sheet.

Table A-4: Supported VSAT modems

## A.1.5 Patents

Patent application number	Description
19203US00	Combined antenna without switch

Table A-5: Patents



## A.2.2 ACU (19 inch rack)

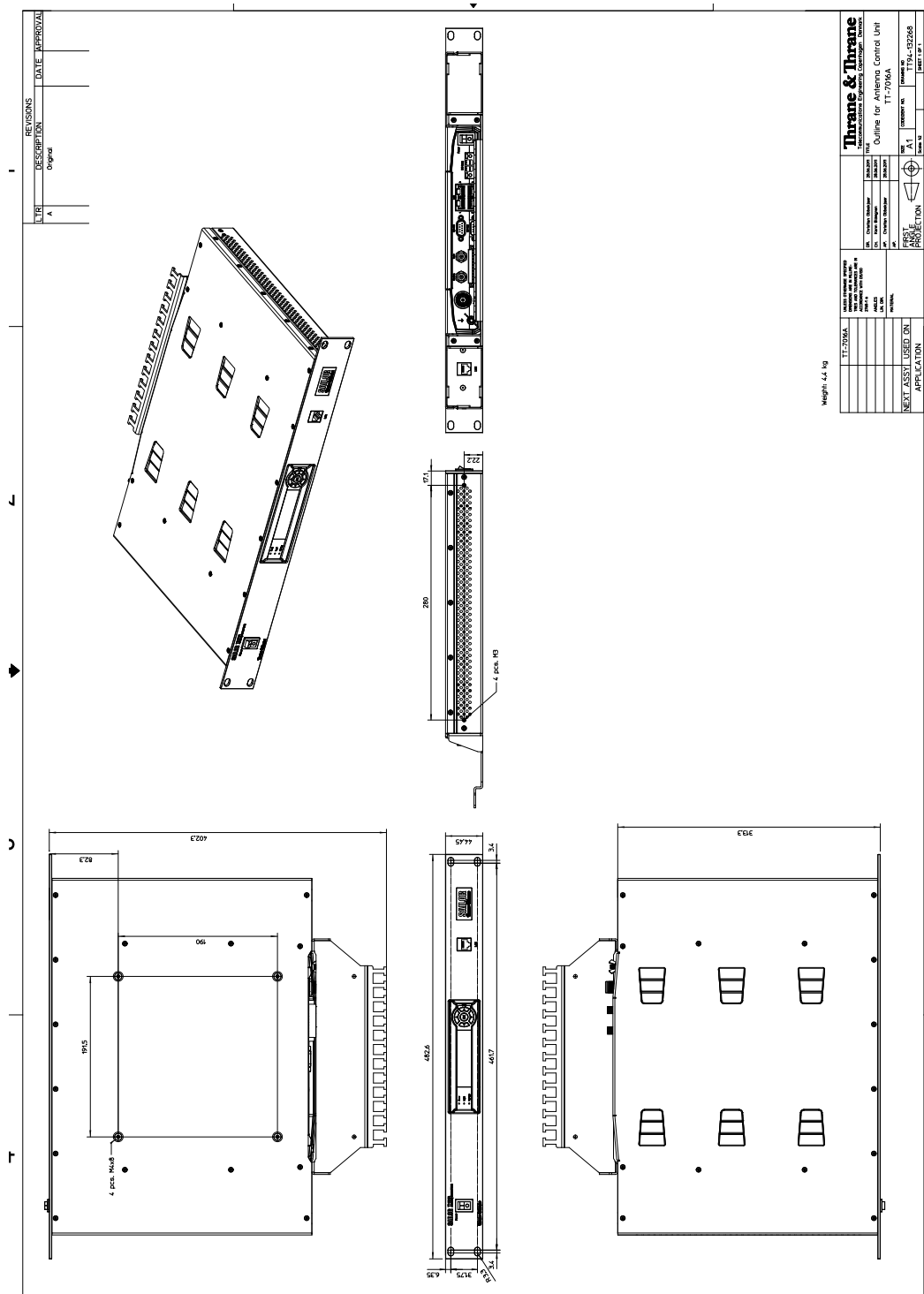

Figure A-2: Outline drawing: ACU, 19 inch rack

### A.2.3 N-connector interface on the ADU

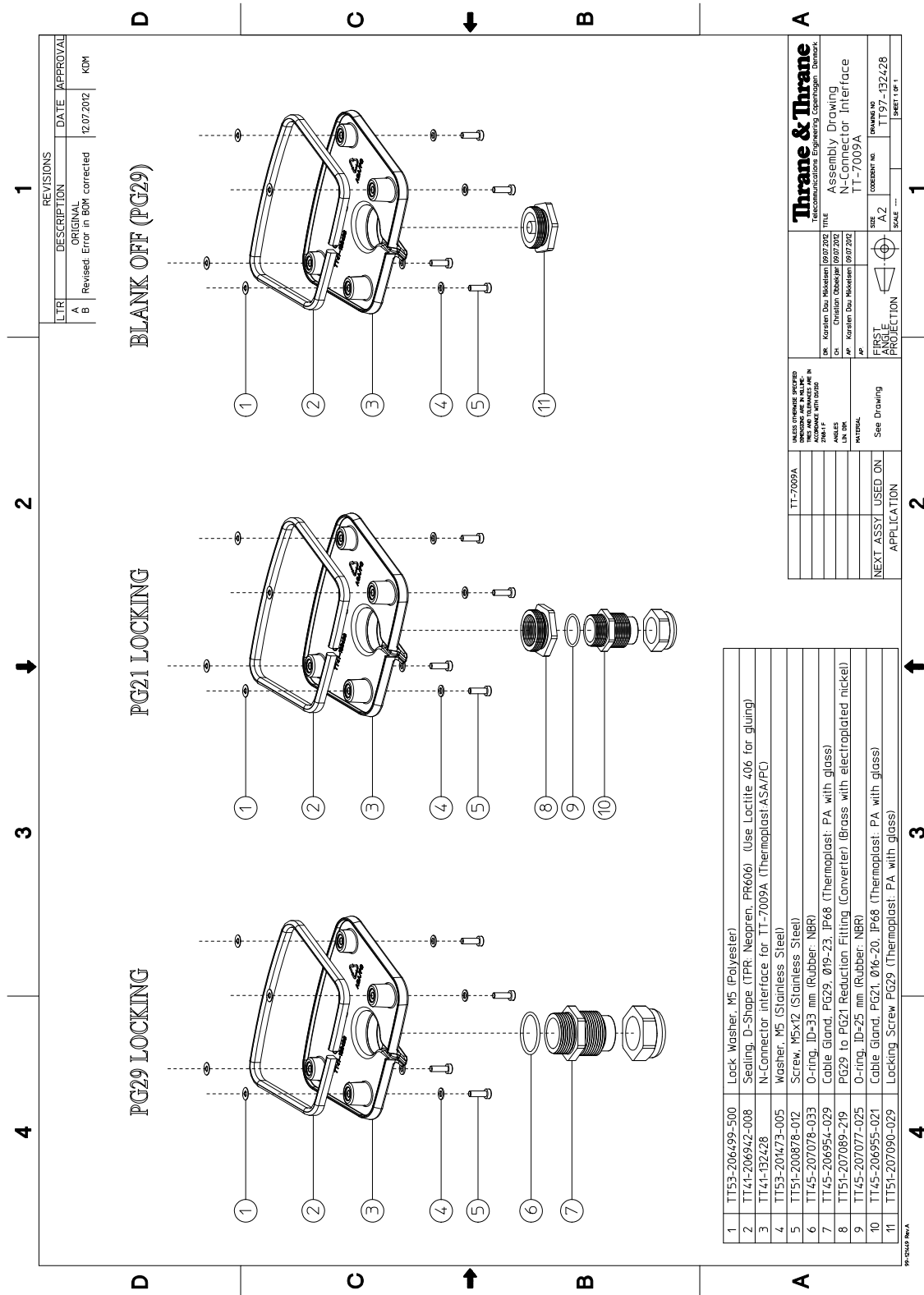

Figure A-3: N-Connector interface on the ADU

## A.3 VSAT LNB Data Sheet (physical LNB)

The following table shows the data of the LNBs which are fitted in the ADU.

The SAILOR 900 VSAT is designed to make any Ku Band frequency in the range of 10.7 GHz to 12.75 GHz available to a VSAT modem by allowing the user to select the LNB LO of his choice — without having to exchange the physical LNBs in the ADU. This is achieved by the sophisticated single-cable solution of the SAILOR 900 VSAT.

Please see A.3.1 for configuration information.

Interface	Model	Spec.
Input, Ku-band	2-band	WR75 waveguide
Output, IF	2-band	F (75 Ohm)
LO type	2-band	Locked to 10 MHz external reference over IF interface or ACU internal
LO frequencies	2-band	9.75, 10.75 GHz

Table A-6: Technical specifications for VSAT LNB 1/2

Parameter	Condition/remark	Unit	Min.	Typical	Max.
Input frequency range	VSAT	GHz	10.7		12,75
Output (IF) frequency range	2-band	MHz	950		2150
VSWR	Input	-			2.0 : 1
	Output	-			1.7 : 1
Noise Figure	At 25 °C	dB		0,8	
LO stability	Over temp. range	kHz	-10	0	10
Gain		dB		60	
Gain (relative)	Over 500 MHz BW	dB	-2.0	0	2.0
Gain (relative)	Over 36 MHz BW	dB	-0.5	0	0.5
External ref. freq. (input)	Nominal	MHz		10	
Power supply voltage	DC	V	11.0		19.0
Supply current	DC	mA			350
LO selection voltage	Voltage, low (L) (input)	V	11.0		14.0
	Voltage, high (H) (input)	V	16.0		19.0

Table A-7: Technical specifications for VSAT LNB 2/2

Parameter	Condition/remark	Unit	Min.	Typical	Max.
Temperature range (ambient)	Operation	°C	-30		75
	Storage	°C	-40		85
Dimensions (incl. connector) over all	L	mm			140
	W	mm			58
	H	mm			50
Weight	Total	g			350

Table A-7: Technical specifications for VSAT LNB 2/2 (Continued)

### A.3.1 VSAT LNB user installation and configuration information

The SAILOR 900 VSAT can interpret 4-band LNB switching signals as well as exact LO information acquired directly from the attached VSAT modem by means of a data connection.

When using a VSAT modem which is integrated to use LO information transferred via a data connection, the LO must be in the range of 9.6 GHz to 11.3 GHz (Optimum values are 9.75 GHz and 10.75 GHz as these match the physical LNB values).

All VSAT modems that can be used with SAILOR 900 VSAT use this approach for selecting the LO frequency, except a COMTECH modem with ROSS server. A COMTECH modem with ROSS server reads switching signals by means of a data connection instead of using voltage and tone signals.

#### Example configuration for an iDirect i5100 (L-Band range 950 - 1700 MHz)

Ku-Band frequency: 11.7389 GHz  
 L-Band frequency: 1638.9 MHz  
 LO: 10.1 GHz

Since the LO frequency of 10.1 GHz is in the range of 9.6 GHz to 11.3 GHz, this is a valid set of data. The SAILOR 900 VSAT will tune to 11.7389 GHz and provide the carrier on the L-Band frequency 1638.9 MHz.

#### Example configuration for a special VSAT modem (L-Band range 950 - 1450 MHz)

Ku-Band frequency: 12.750 GHz  
 L-Band frequency: 1450 MHz  
 LO: 11.3 GHz

Since the LO frequency of 11.3 GHz is in the range of 9.6 GHz to 11.3 GHz, this is a valid set of data. The SAILOR 900 VSAT will tune to 12.750 GHz and provide the carrier on the L-Band frequency 1450 MHz.



## 4-band switching

When using 4-band switching and a VSAT modem which is integrated with SAILOR 900 VSAT to use voltage and tone for switching, the switching is done according to the following table:

LO frequency	Voltage 11-19 V	Tone 22 kHz	Ku band frequency (L-band 950-2150 MHz)
9.75 GHz	11-14 V	Tone off	10.7-11.9 GHz
10.25 GHz	11-14 V	Tone on	11.2-12.4 GHz
10.75 GHz	16-19 V	Tone off	11.7-12.75 GHz
11.25 GHz	16-19 V	Tone on	12.2-12.75 GHz

Table A-8: 4-band switching

Currently none of the VSAT modems which are integrated with the SAILOR 900 VSAT use voltage and tone switching.

## A.4 VSAT 8 W BUC Data Sheet (Extended)

Interface	Model	Spec.
Input, IF	-	N (50 Ohm)
Output, Ku-band	8 W	WR75 waveguide (39.0 dBm min.)
Spectrum	-	Non inverting
LO type	-	Locked to 10 MHz external reference over IF interface or ACU internal
LO frequency	Extended	12.80 GHz
TX ON/OFF	-	10 MHz reference ON/OFF
Cooling	-	External temperature controlled fan - not incl. BUC

Table A-9: Technical specifications for VSAT 8 W BUC 1/2

Parameter	Condition/remark	Unit	Min.	Typical	Max.
Output frequency range	VSAT Ext. TX	GHz	13.75		14.50
Input (IF) frequency range	Extended	MHz	950		1700
VSWR	Input (950 - 1700 MHz)	-			2.0 : 1
	Output (13.75 - 14.50 GHz)	-			2.0 : 1
Output power at P1dB	Worst case	dBm	39.0		
Output power 10 MHz ref OFF	TX band, at -35 dBm ref.	dBm			-60

Table A-10: Technical specifications for VSAT 8 W BUC 2/2

Parameter	Condition/remark	Unit	Min.	Typical	Max.
Gain (absolute linear)	Over output freq. range	dB	61	65	69
Gain (relative)	Over 500 MHz BW	dB	-2.5	0,0	2.5
Gain (relative)	Over 36 MHz BW	dB	-1.0	0,0	1.0
Spurious	RX band	dBc			-60
	TX band	dBc			-15
Phase noise	10 Hz	dBc/Hz			-50
	100 Hz	dBc/Hz			-60
	1 kHz	dBc/Hz			-70
	10 kHz	dBc/Hz			-80
	100 kHz	dBc/Hz			-90
	1 MHz	dBc/Hz			-110
IMD3	At 2 x +33 dBm carriers	dBc			-26
External ref. freq. (input)	Nominal	MHz		10,000000	
External reference freq. (input)	Deviation	Hz	-100	0	100
Power supply voltage	DC	V	20.0		50.0
Supply power	DC	W			85
Temperature range	Operation w. external				
	forced cooling	°C	-30		75
	Storage	°C	-40		85
Dimensions	L	mm			176
	W	mm			170
	H	mm			102
Weight	Total	g			2700

Table A-10: Technical specifications for VSAT 8 W BUC 2/2 (Continued)

# VMU cables

This appendix contains cable specifications for cables between the ACU and a VSAT modem.

- *Modem Cable COMTECH Serial & RSSI TT7016A*
- *Modem Cable iNFINITI iDirect VSAT modem*

# B.1 Modem Cable COMTECH Serial & RSSI TT7016A

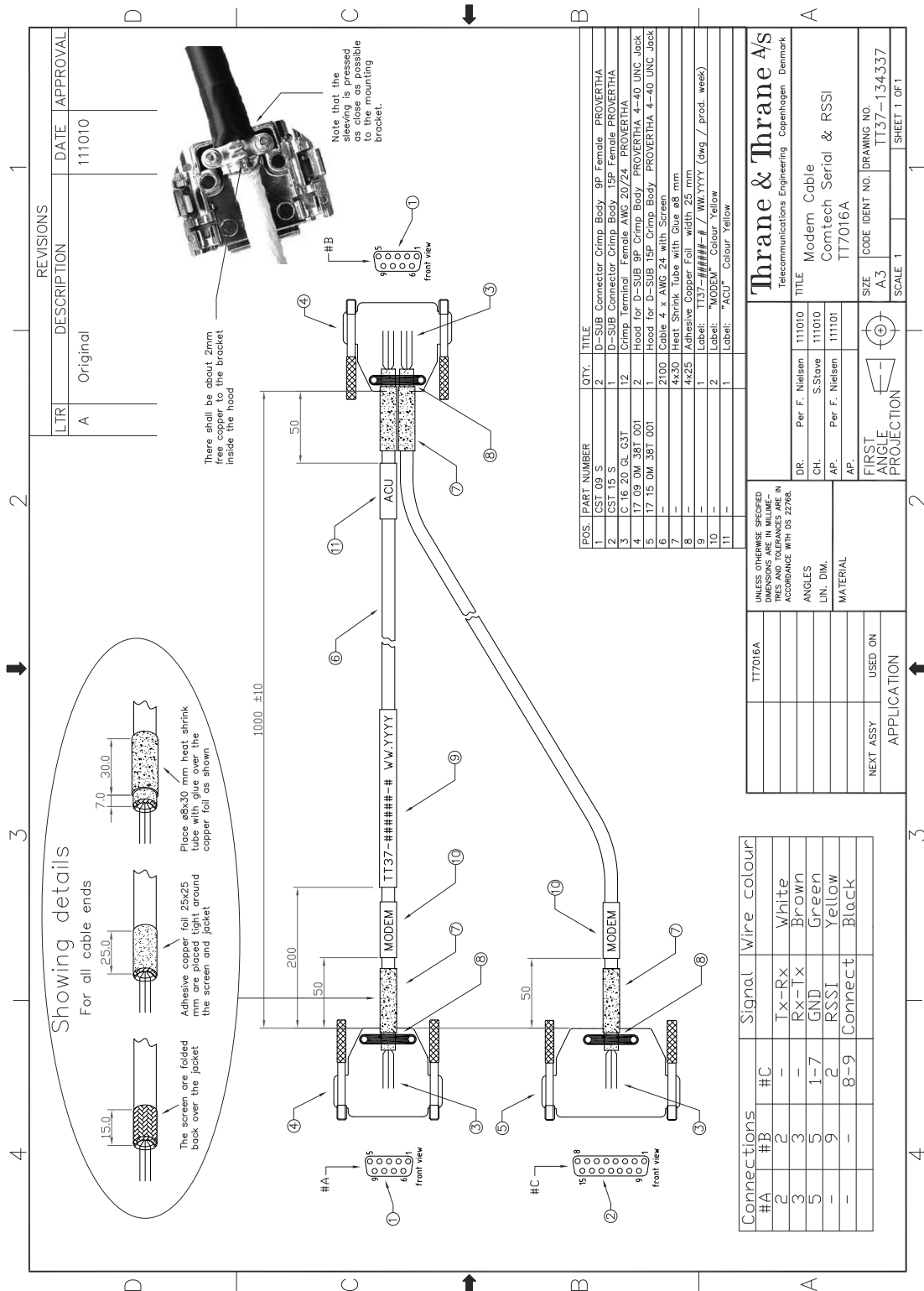

Figure B-1: Modem Cable COMTECH Serial & RSSI TT7016A

## B.2 Modem Cable iNFINITI iDirect VSAT modem

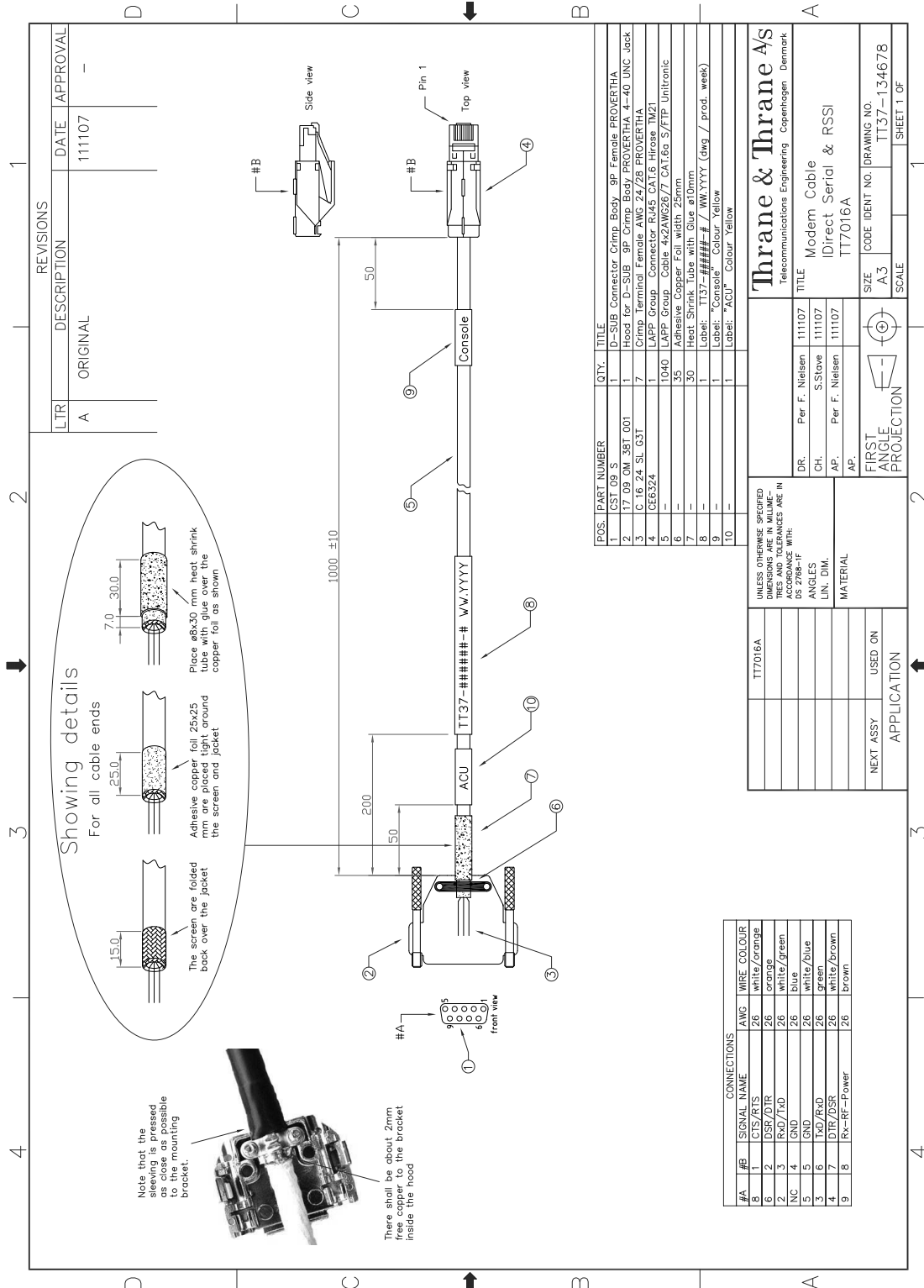

Figure B-2: Modem Cable iNFINITI iDirect VSAT modem



# VMU settings

In this appendix you find detailed information how to set up supported VSAT modems. The following VSAT modems are described:

- *OpenAMIP setup for iDirect iNFINITI 5000 & Evolution X5*
- *Serial setup for iDirect iNFINITI 5000 & Evolution X5*
- *COMTECH 570L and ROSS box*
- *STM SatLink 2900 VSAT modem*
- *Gilat SkyEdge II VSAT modem*
- *Inmarsat G5 modem*

## C.1 OpenAMIP setup for iDirect iNFINITI 5000 & Evolution X5

### C.1.1 Protocol and interfaces

#### Introduction

The following sections describe the protocol and interface between the SAILOR 900 VSAT ACU and an iDirect OpenAMIP VSAT modem. OpenAMIP operation is normally used by service providers offering global VSAT service as the protocol supports roaming between satellites (Automatic Beam Switching).

OpenAMIP, an ASCII message based protocol invented and Trademarked by iDirect is a specification for the interchange of information between an antenna controller (ACU) and a VSAT modem (VMU). This protocol allows the VSAT modem to command the ACU to search and lock to a particular satellite as well as allowing exchange of information necessary to permit the VSAT modem to initiate and maintain communication via the antenna and the satellite. In general, OpenAMIP is not intended for any purpose except to permit a modem and the ACU to perform synchronized automatic beam switching.

Thrane & Thrane A/S received OpenAMIP certification for SAILOR 900 VSAT from VT iDirect Inc. on 22 September 2011.

#### Connections

Connect the ACU and iDirect modem with the following cables:

- Ethernet cable for TCP/IP data communication
- RS-232 console cable for signal strength indication (part number: 407090A-020)
- 75 Ohm RF cables F-F connectors for rx and tx frequencies.

See *Connecting an iNFINITI® Series Satellite Router* on page 4-7 and *Connecting an Evolution® Satellite Router* on page 4-8 for details on cable connections and pin allocation for the RS-232 Console cable.

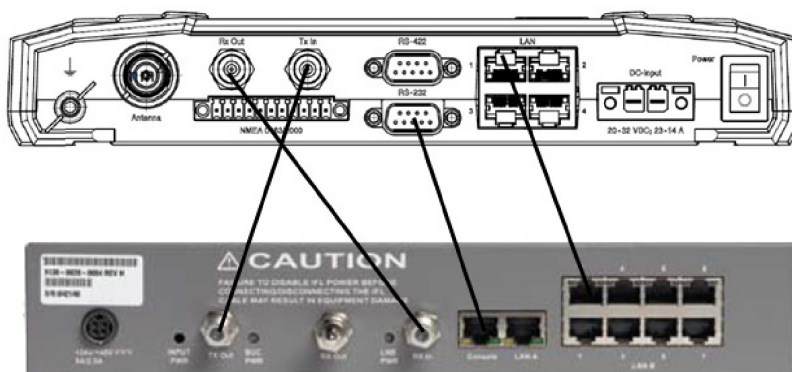

Figure C-1: Connecting iDirect iNFINITI 5000 series to the ACU (OpenAMIP)



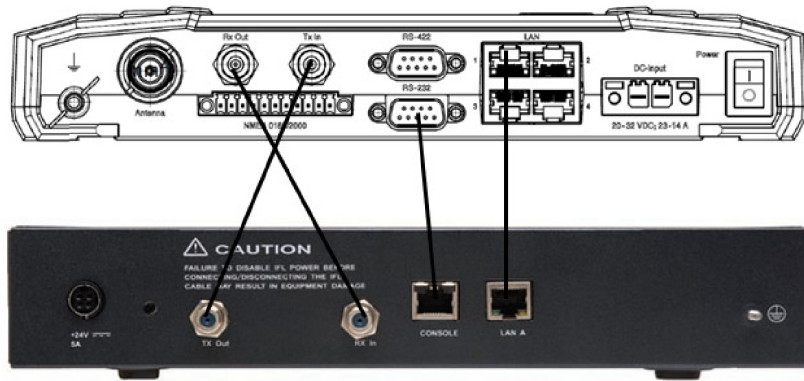

Figure C-2: Connecting iDirect Evolution X5 to the ACU (OpenAMIP)

### Protocol

The SAILOR 900 VSAT ACU supports all OpenAMIP commands except the X command which is optional. All the supported OpenAMIP commands are shown in the following figure.

iDS/iDX Release	Messages Sent from Remote			Options File Group	Messages Sent from Antenna	
	Message	# Parameters	Mapped to Options File Keys		Message	# Parameters
iDX 2.0.x	A		keepalive_interval Default value of 15 seconds. Will not appear in Options file unless overwritten.	[ANTENNA]	a	
	B	2	rx_lcl_osc, tx_lcl_osc	[SATELLITE]		
	H	2	hunt_frequency, hunt_bandwidth	[SATELLITE]		
	K	1	max_skew Maximum skew of the beam short axis to the geosynchronous arc.	[SATELLITE]		
	P	2	polarity, tx_polarity	[SATELLITE]		
	S	3	longitude, max_lat, pol_skew	[SATELLITE]	s	2
	T	2	tx_frequency, tx_bandwidth	[SATELLITE]		
	W	1	latlong_interval Message contains single value in seconds. Does not generate Options file key.	[MOBILE]	w	4

Figure C-3: Supported OpenAMIP commands

Messages sent from VSAT modem	Explanation
S -15.000000 0.000000 0.000000	Longitude, Max_lat, Pol_skew
H 1451.815000 1.905000	Hunt_frequency, Hunt_bandwidth
P H V	Rx_polarity, Tx_polarity

Table C-1: Messages sent from the VSAT modem to the ACU (examples)

Messages sent from VSAT modem	Explanation
B 11250.000000 12800.000000	Rx-icl_osc, Tx_icl_osc
T 1403.290000 0.618000	Tx_frequency, Tx_bandwidth
A 15	Keepalive_interval in mS [ACU: s message]
W 300	latlong_interval in seconds [ACU: w message]
L 1 1	Modem locked
K 90.000000	Max_skew

Table C-1: Messages sent from the VSAT modem to the ACU (examples)

Messages sent from the ACU to the VSAT modem	Explanation
s 1 1	Functional, Tx OK
w 1 55.794010 12.52272 985523005	GPS valid, Latitude, Longitude, Time

Table C-2: Messages sent from the ACU to the VSAT modem (examples)

**Note** The iDirect modems only sends the satellite information once when booting. If the ACU has not received the information for some reason, the system cannot point. In that case the modem will automatically boot after 5 minutes and send the satellite information again.

The signal strength from the modem is measured on RS-232 pin 9. It is a DC voltage in the range of 0 - 5 VDC.

Ranges for signal strength	
VDC	Antenna status
0-2.5	RF energy is detected, but from the wrong satellite.
2.6-5.0	Carrier lock, correct satellite.

Table C-3: Ranges for signal strength for iDirect OpenAMIP VSAT modem

The signal strength displayed web interface on the Dashboard as 0 – 500. The minimum value for an Internet connection is 250 - 260.

## C.1.2 Sample options file

The following section presents a portion of a sample iDX 2.0.x Options file with OpenAMIP messages and parameters defined. OpenAMIP keys appear highlighted in bold.

```
[OPTIONS_FILE]
product_mode = idirect_scpc
modem_sn = 40170
generated_by = NMS-10.0.0
did = 12885226
modem_type = Remote
modem_hardware = 5000
is_mesh = 0
disable_options_flash_command = 0
carrier_type = 0
...
[MOBILE]
is_mobile = 1
tx_handshake_enabled = 0
gps_input = 2
latlong_interval = 300
latlong_fail_interval = 10
init_tx_power_offset = 0.000000
[MAPSERVER_0]
hostname = 172.20.130.3
port = 5003
[BEAMS]
beam_21 = PPS_Perf_Eval
maxbeam = 21
[ANTENNA]
manufacturer = OpenAMIP
model = OpenAMIP
addr = 172.26.81.34
port = 2000
connect_timeout = 30
dedicated_interface = ixp1
[SATELLITE]
min_look_angle = 0.000000
tx_frequency = 1300.000000
tx_bandwidth = 36.000000
hunt_bandwidth = 36.000000
rx_lcl_osc = 11250.000000
tx_lcl_osc = 12800.000000
max_skew = 90.000000
name = T12
channelname = T12_EMEA
longitude = -15.000000
max_lat = 0.000000
pol_skew = 0.000000
hunt_frequency = 1075.000000
polarity = H
```

**tx\_polarity = X**

noise\_reference\_frequency = 0.000000

The option file must use following information:

Section in the option file	Requirements
[SATELLITE]	<p>The modem provides RX and TX frequency information via a data connection to the SAILOR 900 VSAT.</p> <p>The single-cable solution makes it possible to configure the VSAT modem to use any LO frequency in the range from 9.6 GHz to 11.3 GHz. The SAILOR 900 VSAT will tune to the correct Ku-Band frequency and provide the correct L-Band frequency to the VSAT modem.</p> <p>Example: "rx_lcl_osc = 11250.000000"</p> <p>SAILOR 900 has an extended 8 Watt BUC with LO up conversion frequency of 12.8 GHz.</p> <p>— Example: "tx_lcl_osc = 12800.000000"</p> <p><b>Note:</b> SAILOR 900 VSAT supports any LNB frequency due to the 1-cable design.</p>
[MOBILE]	<p>The iDirect modem must be set to mobile unit and receive the GPS information from the ACU with the command "w &lt;Valid&gt; &lt;Lat&gt; &lt;Lon&gt; &lt;Time&gt;".</p> <p><b>Example:</b> "is_mobile = 1"</p> <p>Tx handshake must not be enabled in the iDirect modem.</p> <p><b>Example:</b> "tx_handshake_enabled = 0"</p>
[ODU]	<p>The SAILOR 900 VSAT can work either using the Rx or Tx 10 MHz reference signals provided by the modem or using its own built-in 10 MHz reference signal. It is recommended to use the Tx 10 MHz reference signal from the modem. See also <i>VSAT modem profile – New entry and Edit</i> on page 6-22.</p> <p><b>Example:</b> "odu_rx_10_mhz = 1"</p> <p>The SAILOR 900 VSAT needs the Tx 10 MHz reference signal in order to allow TX ON.</p> <p><b>Example:</b> "odu_tx_10_mhz = 1"</p>

Table C-4: Information in the VSAT modem option file

### C.1.3 Configuration example (OpenAMIP)

Examples of modem profile and satellite configuration from the ACU web MMI are shown in the figures below.

**ADD VSAT MODEM PROFILE**

Profile name: iDirect Evolution (Open AMIP)

VSAT modem: iDirect Evolution (OpenAMIP)

This profile is used on: 0 Satellite profiles

10 MHz reference: External - VMU Tx

Port: 2000

Apply Cancel

Figure C-4: VSAT modem profile, OpenAMIP (example)

**ADD SATELLITE PROFILE**

Satellite profile name: VSAT Global

VSAT modem profile: iDirect Evolution (OpenAMIP)

Elevation cutoff: 10 °

**TRACKING**

Tracking type: Narrow band

RX frequency:  VSAT modem  User defined

Apply Cancel

Figure C-5: Satellite profile, OpenAMIP (example)

Simple OpenAMIP protocol in iDS 8.0.2.7 is **NOT** supported by the SAILOR 900 VSAT.  
Full OpenAMIP protocol from iDX 2.0 and up is supported by the SAILOR 900 VSAT.

## C.1.4 Troubleshooting

It is expected that the modem has been connected with cables to the ACU and that an iDirect OpenAMIP modem profile and satellite profile have been configured in the web server of the SAILOR 900 VSAT and has been activated. For further details see *Configuration example (OpenAMIP)* on page C-7.

It is recommended to connect the service PC to LAN port 2 of the ACU in order to have access to the web server of the SAILOR 900 VSAT and IP connection to the attached iDirect OpenAMIP modem.

A telnet or ssh client and Internet browser is needed in order to go through the troubleshooting guidelines. It is recommended to use the telnet/ssh client program called PuTTY, which is available for free on the Internet (<http://www.putty.org/>).

1. Default login to iDirect modems are: User name: admin, Password: P@55w0rd!
2. Every time a setting is changed in the iDirect modem, it must be stored in flash using the following command line command:  
`options flash`
3. After changing a setting and storing the new setting the modem has to boot its application in order to read and use the new setting. This is done with the command line command:  
`reset application`

The iDirect options file is divided into sections; the section name is always CAPITAL letters. Each section has several parameters, and each parameter has a value. See the following example:

```
[MOBILE]
  gps_input = 2
  init_tx_power_offset = 0.000000
  is_mobile = 1
  latlong_interval = 60
  tx_handshake_enabled = 0
```

To change a setting in the MOBILE section use the `options set` command. See example of command here:

```
options set MOBILE gps_input 2
```

Note that setting the `gps_input` parameter to value 2 is written without an equal sign but only with a space character between parameter name and the value.

You can use the following flow chart and the instructions in the notes later in this appendix.

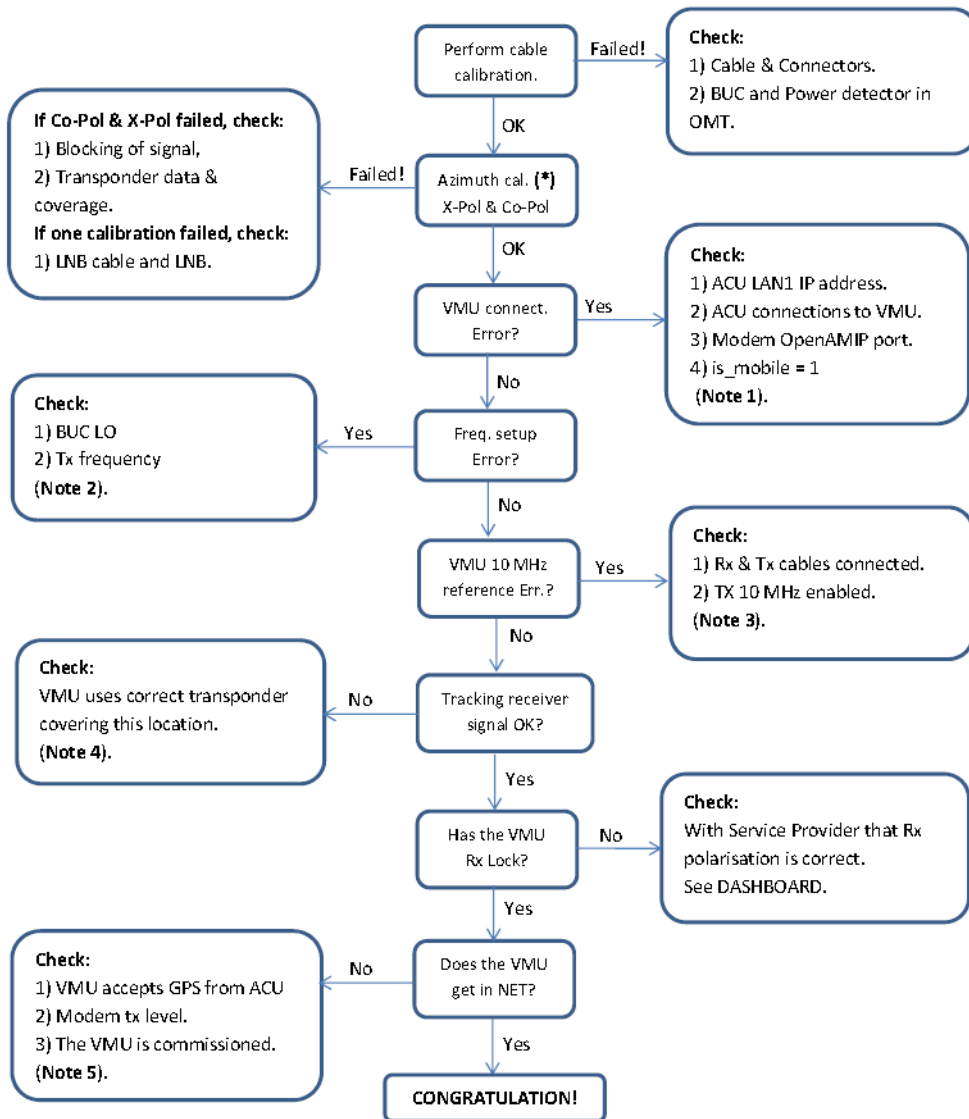

VMU settings

\* Use same transponder polarity with both calibrations.

Figure C-6: iDirect OpenAMIP troubleshooting

**Note 1:** Connect to modem with Telnet or serial and issue following commands:

```
options show ANTENNA
Check: IP address, port # and manufacturer = OpenAMIP.
options show MOBILE
Check: is_mobile = 1
```

**Note 2:** Connect to modem with telnet and issue command:

```
options show SATELLITE
Check: tx_lcl_osc = 12800.000000,
Check: tx_frequency is between: 950.000000 to 1700.000000
Check: rx_lcl_osc + hunt_frequency is between: 10.7 GHz to 12.75 GHz
```

**Note 3:** Connect to the modem with Telnet and issue commands:

```
options show ODU
Check: odu_tx_10_mhz = 1
options show MOBILE
Check: tx_handshake_enabled = 0
```

**Note 4:** Connect to the modem with Telnet and issue command:

```
beamselector list
```

Write down the transponder number for one of the beams that has line of sight.  
Use the command: beamselector switch <number> -f to force the VMU to use this transponder. E.g:

```
beamselector switch 323 -f
```

Use the command: beamselector lock to lock the VMU to this transponder and stay there (until power cycle or reset application).

**Note 5:** Connect to the modem with Telnet and issue commands:

```
options show MOBILE
Check: gps_input = 2
tx power
```

Try to increase the tx power step by step up to max. -5 dBm, which is around SAILOR 900 VSAT P1dB level. E.g. tx power -10

## Examples of commands

```
options set SATELLITE tx_frequency 1450
options set MOBILE gps_input 2
options set MOBILE is_mobile 1
options set MOBILE tx_handshake_enabled 0
options set ODU odu_tx_10_mhz 1
options flash
```

If this fails then the options file is write protected!  
Change disable\_options\_flash\_command = 0 first!

```
options set OPTIONS_FILE disable_options_flash_command 0
reset application
```

Starts the VMU application (soft boot)

- Notice that changing options file locally can help determine wrong settings. The settings will probably be changed back to original settings when the VMU get synchronized with the hub.
- Tell the NOC about the faulty settings so they can correct configuration.



## C.2 Serial setup for iDirect iNFINITI 5000 & Evolution X5

### C.2.1 Protocol and interfaces

#### Introduction

The following sections describe the protocol and interface between the ACU and an iDirect Serial modem. Serial operation is normally used by service providers offering regional VSAT service.

#### Connections

Connect the ACU and iDirect modem with the following cables:

- RS-232 console cable for control communication
- 75 Ohm RF cables F-F connectors for rx and tx frequencies.

See *Connecting an iNFINITI® Series Satellite Router* on page 4-7 and *Connecting an Evolution® Satellite Router* on page 4-8 for details on cable connections.

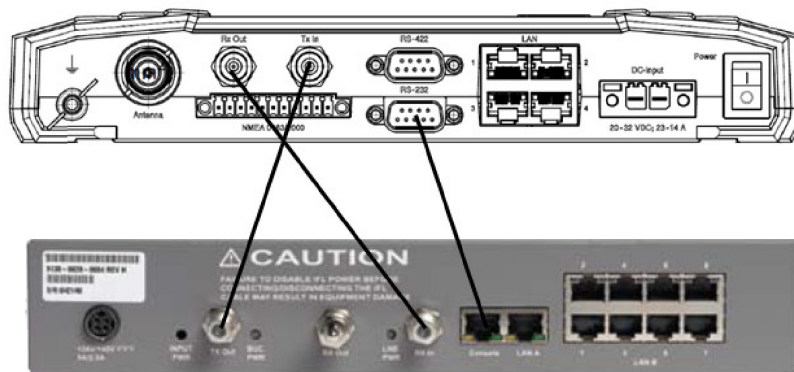

Figure C-7: Connecting iDirect iNFINITI 5000 series to the ACU (Serial)

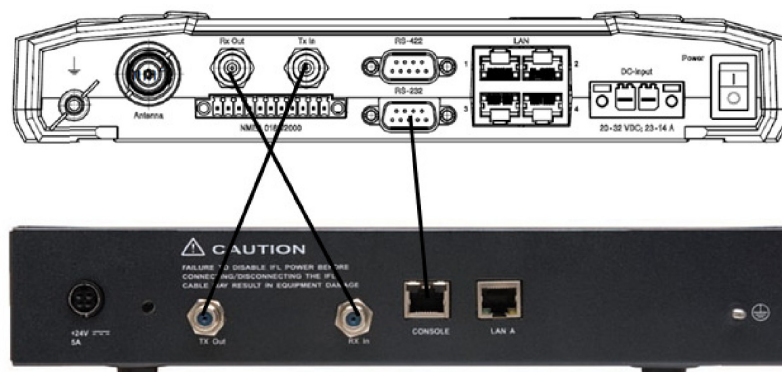

Figure C-8: Connecting iDirect Evolution X5 to the ACU (Serial)

The pin allocation for the RS-232 Console cable is shown below. See also Appendix B on page C-1 for a cable drawing.

Console port (DTE)	RJ-45 pin	Color code	RJ-45 to DB-9 adapter pin	Console device
RTS	1	Blue	8	CTS
DTR	2	Orange	6	DSR
TxD	3	Black	2	RxD
GND	4	Red	NC	GND
GND	5	Green	5	GND
RxD	6	Yellow	3	TxD
DSC	7	Brown	4	DTR
Rx-RF Power	8	White/Grey	9	--

Table C-5: RS-232 Console cable for iDirect Serial VSAT modem

## C.2.2 Console port settings

The iDirect modem must be configured to use following console port settings:

- Baud rate: 4800 or 9600
- Data bits: 8
- Parity: None
- Stop bit: 1

### Passwords

The SAILOR 900 VSAT ACU will log in to the modem using root and user passwords. The default passwords are:

- Root: P@55w0rd!
- User: iDirect

### Supported commands

After login to the modem the ACU will issue commands to the modem every second. The following commands are supported by the SAILOR 900 ACU:

- rx snr
- options show FREQ\_TRANS
- rx freq
- tx freq
- latlong <lat> <long>

The signal strength command: rx snr is issued every 2 seconds. The rest of the commands are issued one by one every 2 seconds between each signal strength command. Meaning each of the other commands is issued every 8 seconds.

The signal strength in the ACU display and web interface is shown as dB., e.g: 8.5 dB. The minimum value for Internet connection is around 2-3 dB.

## VSAT modem option file

The option file of the VSAT modem must also include the following information:

Section in option file	Description
Satellite information	Receive frequency of the transponder. Used with “rx freq” command Transmit frequency if known otherwise just a dummy tx frequency (e.g. 1.450 MHz). Used with “tx freq” command.
SAILOR 900 VSAT information	The modem provides RX and TX frequency information via a data connection to the SAILOR 900 VSAT.  The single-cable solution makes it possible to configure the VSAT modem to use any LO frequency in the range from 9.6 GHz to 11.3 GHz. The SAILOR 900 VSAT will tune to the correct Ku-Band frequency and provide the correct L-Band frequency to the VSAT modem.  The SAILOR 900 VSAT has an extended 8 Watt BUC with LO up conversion frequency of 12.8 GHz.
GPS	The iDirect modem must be set to mobile unit and receive the GPS information from the ACU with the command “latlong <lat> <long>”.  Tx handshake must be disabled in the iDirect modem.
Rx 10 MHz	The SAILOR 900 VSAT can work either using the Rx or Tx 10 MHz reference signals provided by the modem or using its own built-in 10 MHz reference signal. It is recommended to use the Tx 10 MHz reference signal from the modem. See also <i>VSAT modem profile – New entry and Edit</i> on page 6-22.
Tx 10 MHz	The SAILOR 900 VSAT needs the Tx 10 MHz reference signal in order to allow TX ON.

Table C-6: Requirements for VSAT modem option file, Serial

### C.2.3 Configuration example (Serial)

Examples of modem profile and satellite configuration from the ACU web MMI are shown in the figures below.

**ADD VSAT MODEM PROFILE**

Profile name: iDirect Evolution (Serial)

VSAT modem: iDirect Evolution (Serial)

This profile is used on: 0 Satellite profiles

VSAT modem root password: P@55w0rd!

VSAT modem user password: iDirect

Baud rate: 4800 baud

10 MHz reference: External - VMU Tx

Apply Cancel

Figure C-9: VSAT modem profile, Serial (example)

**ADD SATELLITE PROFILE**

Satellite profile name: VSAT Regional

VSAT modem profile: iDirect Evolution (Serial)

---

Predefined satellites: User defined data..

Satellite position: 37.5 W °

Polarisation skew: 0 °

Maximum inclination: 0 °

Elevation cutoff: 10 °

RX polarisation:  Horizontal  Vertical

TX polarisation:  Co-pol  X-pol

**TRACKING**

Tracking type: Narrow band

RX frequency:  VSAT modem  User defined

Apply Cancel

Figure C-10: Satellite profile, Serial (example)

## C.3 COMTECH 570L and ROSS box

### C.3.1 Protocols and interfaces

The following sections describe how to connect an ACU, a COMTECH570L VSAT modem, a ROSS box and an Ethernet switch.

From software version 1.30 or higher the SAILOR 900 VSAT supports COMTECH ROSS ROAM protocol 1+ which includes the satellite longitude in the responses from the ACU to the ROSS box. 1.30 also supports setting inclined orbit by entering user defined data.

#### Connections

Connect the ACU and COMTECH 570L, ROSS box and Ethernet switch with the following cables:

- Ethernet cables for TCP/IP data communication (x3)
- RS-232 console cable
- 75 Ohm RF cables F-F connectors for rx and tx frequencies.

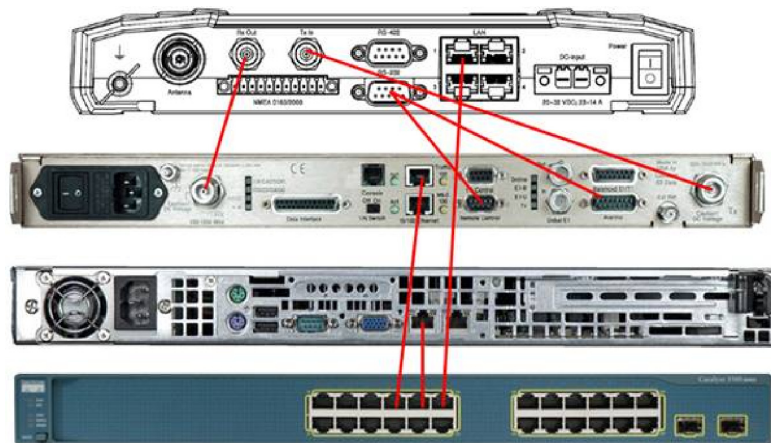
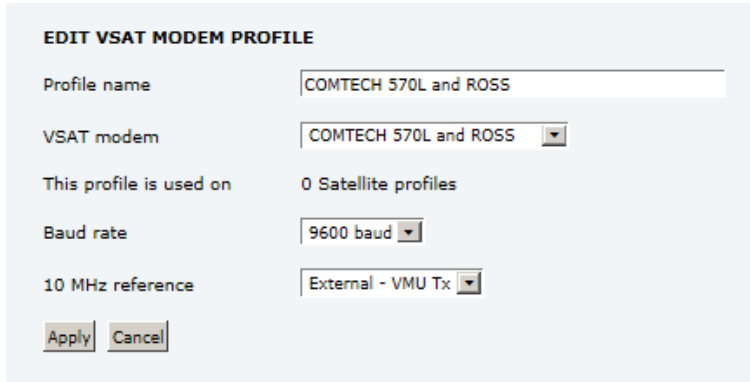

Figure C-11: Connecting COMTECH 570L and ROSS box to the ACU (example)

See also *Connecting a COMTECH 570 L or 625 Satellite Modem* on page 4-8 and cable specifications at *Modem Cable COMTECH Serial & RSSI TT7016A* on page B-2.

### C.3.2 Configuration example (COMTECH 570L and ROSS)

Examples of modem profile and satellite configuration from the ACU web MMI are shown in the figures below.



**EDIT VSAT MODEM PROFILE**

Profile name	<input type="text" value="COMTECH 570L and ROSS"/>
VSAT modem	<input type="text" value="COMTECH 570L and ROSS"/>
This profile is used on	0 Satellite profiles
Baud rate	<input type="text" value="9600 baud"/>
10 MHz reference	<input type="text" value="External - VMU Tx"/>

Figure C-12: VSAT modem profile, COMTECH 570L and ROSS (example)

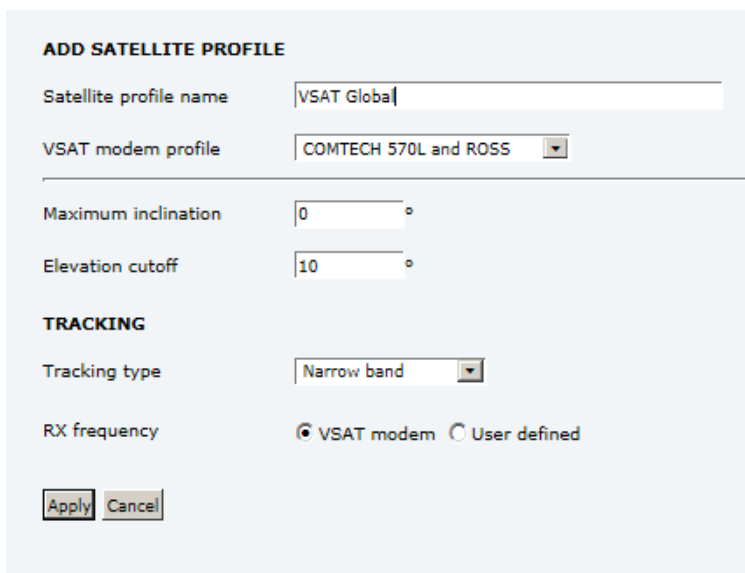

**ADD SATELLITE PROFILE**

Satellite profile name	<input type="text" value="VSAT Globa"/>
VSAT modem profile	<input type="text" value="COMTECH 570L and ROSS"/>

---

Maximum inclination	<input type="text" value="0"/> °
Elevation cutoff	<input type="text" value="10"/> °

**TRACKING**

Tracking type	<input type="text" value="Narrow band"/>
RX frequency	<input checked="" type="radio"/> VSAT modem <input type="radio"/> User defined

Figure C-13: Satellite profile, COMTECH 570L and ROSS (example)

## C.4 STM SatLink 2900 VSAT modem

### C.4.1 Interfaces and VSAT modem configuration

The following sections describe how to connect an ACU to an STM SatLink 2900 VSAT modem. The STM SatLink 2900 and the SAILOR 900 VSAT are fully integrated and require almost no user setup.

STM SatLink 2900 software version required: 14.2.0 or higher.

#### Connections

Connect the ACU and STM SatLink 2900 with the following cables:

- Ethernet cable for TCP/IP data communication. Connect LAN A on the VSAT modem to LAN 1 on the ACU.
- 75 Ohm RF cables F-F connectors for RX and TX frequencies

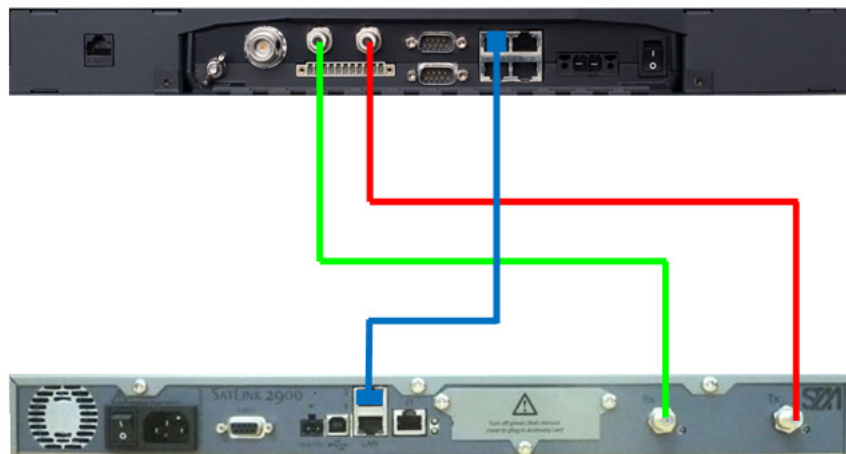

Figure C-14: Connecting STM SatLink 2900 VSAT modem to the ACU

See also *Connecting a Satlink 2900 VSAT modem* on page 4-10.

#### Modem configuration requirements

Type the following command in a modem console to set up the STM Satlink 2900 modem to use the SAILOR 900 VSAT:

```
odu antenna 30
odu txttype 62
odu lnb 62
```

To display the antenna setup for the STM Satlink 2900 modem, type:

```
odu antctrl show
```

#### Example:

```
odu antctrl show
Antenna Controller Configuration
```

```
-----  
Type                : Thrane & Thrane SAILOR 900  
Enabled             : All  
IP address          : 10.110.2.226  
Polling frequency  : 5 sec  
Antenna Stability Tries : 300
```

Antenna Controller Status

```
-----  
Controller detected : no  
Packets sent       : 0  
Packets received   : 0
```

## C.4.2 ACU configuration

To set up the ACU to work with an STM Satlink 2900 VSAT modem, do as follows:

1. Add a modem profile with the STM Satlink 2900 modem. See *VSAT modem profile – New entry and Edit* on page 6-22.
2. Add a satellite profile using the STM Satlink modem profile just created. See *Satellite profiles – New entry and Edit* on page 6-20.
3. Edit the network settings and input the IP information supplied with the modem. See *Configuring the LAN network* on page 6-26.
4. Activate the satellite profile.



### C.4.3 Configuration example (STM Satlink 2900)

Examples of modem profile and satellite configuration from the ACU web MMI are shown in the figures below.

**EDIT VSAT MODEM PROFILE**

Profile name: STM SatLink 2900

VSAT modem: STM SatLink 2900

This profile is used on: 0 Satellite profiles

10 MHz reference: External - VMU Tx

Apply Cancel

Figure C-15: VSAT modem profile, STM SatLink 2900 (example)

**ADD SATELLITE PROFILE**

Satellite profile name: VSAT Globa|

VSAT modem profile: STM SatLink 2900

Elevation cutoff: 10 °

**TRACKING**

Tracking type: Narrow band

RX frequency:  VSAT modem  User defined

Apply Cancel

Figure C-16: Satellite profile, STM SatLink 2900 (example)

## C.5 Gilat SkyEdge II VSAT modem

### C.5.1 Interfaces and VSAT modem configuration

The following sections describe how to connect an ACU to a Gilat SkyEdgeII VSAT modem. The Gilat SkyEdge II and the SAILOR 900 VSAT are fully integrated and require only little user setup.

#### Connections

Connect the ACU and Gilat SkyEdge II with the following cables:

- Ethernet cable for TCP/IP data communication. Connect LAN A on the VSAT modem to LAN 1 on the ACU.
- 75 Ohm RF cables F-F connectors for RX and TX frequencies

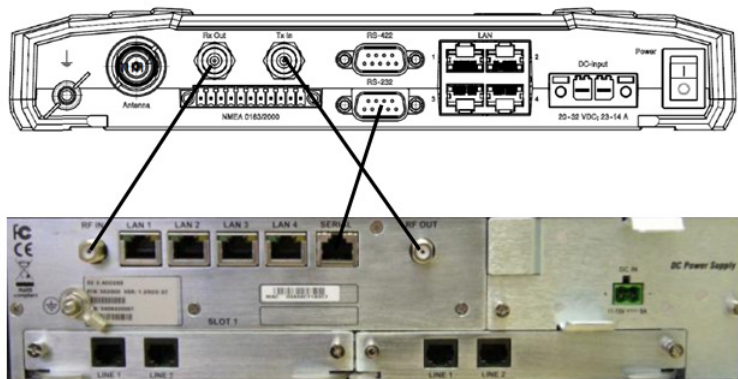

Figure C-17: Connecting Gilat SkyEdge II VSAT modem to the ACU

See also *Connecting a Gilat SkyEdge II VSAT modem* on page 4-10.

#### Modem configuration requirements

1. Connect a PC with an Ethernet cable to LAN port 1 of the VSAT modem.
2. Set the PC to static IP address: 192.168.1.2
3. Start an Internet browser (e.g. Internet Explorer) and go to URL://192.168.1.1 in order to get access to the web server of the VSAT modem.
4. Login with: User name: inst and Password: \$Sat2598\$
5. Go to the menu **Installer**.

Parameter	Settings
RF Downlink frequency	In the section <b>General</b> the RF Downlink frequency is shown. Write it down as it is going to be used for the selection of LNB LO.  Further down on the page you find the BUC and LNB LO frequencies.

Table C-7: Configuration of Gilat SkyEdge II VSAT modem

Parameter	Settings
LNB LO	Depending on the RF Downlink frequency select an appropriate LNB LO of 9.75, 10.25, 10.75 or 11.25 GHz which will result in an L-band frequency between 950 and 1650 MHz which is the operating frequency band of the SkyEdge II Access modem.
BUC LO	Select the BUC to be 12.8 GHz as this is the BUC LO of the SAILOR 900 VSAT. Remember to inform the hub operator about this when doing line up and commissioning.
BUC 10MHz Reference Signal	The BUC 10MHz Reference Signal must be configured to ON, otherwise the SAILOR 900 VSAT will never allow TX. Scroll further down to enable GPS for the Location Coordinates. This enables the serial protocol of the modem so it can communicate with the ACU.

Table C-7: Configuration of Gilat SkyEdge II VSAT modem

6. Go to the top of the page and press the **Submit** button and **OK** to save the new settings.

The VSAT modem is now configured to be used with the SAILOR 900 VSAT.

## C.5.2 ACU configuration

To set-up the ACU to work with a Gilat SkyEdge II VSAT modem, do as follows:

1. Add a modem profile with the Gilat SkyEdge II modem. See *VSAT modem profile – New entry and Edit* on page 6-22.
2. Add a satellite profile using the Gilat SkyEdge II modem profile just created. See *Satellite profiles – New entry and Edit* on page 6-20.
3. Edit the network settings and input the IP information supplied with the modem. See *Configuring the LAN network* on page 6-26.
4. Activate the satellite profile.

See also the configuration example in the following section.

### C.5.3 Configuration example (Gilat SkyEdge II )

Examples of modem profile and satellite configuration from the ACU web MMI are shown in the figures below.

**EDIT VSAT MODEM PROFILE**

Profile name

VSAT modem

This profile is used on 0 Satellite profiles

Baud rate

10 MHz reference

Figure C-18: VSAT modem profile, Gilat Sky Edge II (example)

**ADD SATELLITE PROFILE**

Satellite profile name

VSAT modem profile

---

Predefined satellites

Satellite position  °

Polarisation skew  °

Maximum inclination  °

Elevation cutoff  °

RX polarisation  Horizontal  Vertical

TX polarisation  Co-pol  X-pol

LNB LO frequency

TX RF frequency  GHz

**TRACKING**

Tracking type

RX frequency  VSAT modem  User defined

Figure C-19: Satellite profile, Gilat Sky Edge II (example)

## C.6 Inmarsat G5 modem

### C.6.1 Interfaces and VSAT modem configuration

Inmarsat G5 is delivered in a pre-wired and fully configured 19" rack by Inmarsat.

### C.6.2 Connecting a Inmarsat G5 modem

Inmarsat G5 is delivered in a pre-wired and fully configured 19" rack by Inmarsat.

### C.6.3 Configuration example (Inmarsat G5)

Examples of modem profile and satellite configuration from the ACU web MMI are shown in the figures below.

**EDIT VSAT MODEM PROFILE**

Profile name

VSAT modem

This profile is used on

10 MHz reference

Port

Figure C-20: VSAT modem profile, Inmarsat G5 (example)

**ADD SATELLITE PROFILE**

Satellite profile name

VSAT modem profile

---

Elevation cutoff  °

**TRACKING**

Tracking type

RX frequency  VSAT modem  User defined

Figure C-21: Satellite profile, Inmarsat G5 (example)



# Command line interface

## D.1 Introduction

After you have done the initial configuration and connected the SAILOR 900 VSAT to your network, you can configure the SAILOR 900 VSAT by using Telnet. You can also setup VSAT modem parameters.

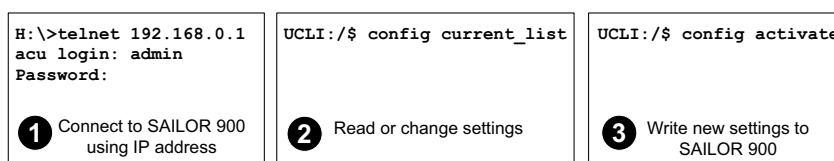

Figure D-1: How to use the command line interface (example for telnet)

After successful login you can read and change settings. Use the command **config activate** to activate the new settings in the ACU.

You will need to refresh the browser window before the changed settings become visible.

### Note

Every change is performed on the active satellite profile or the active VSAT modem profile.

Parameter identifiers are case sensitive.

### D.1.1 Telnet connection

You can access the command line interface via Telnet.

#### User name and password

Access to the SAILOR 900 VSAT system is protected by a user name and password. This is the same user name and password that is used in the web interface under **ADMINISTRATION**, for further details see *Accessing the administration settings (user name, password)* on page 6-39.

#### Telnet

The interface is on the standard Telnet port 23. Use any LAN port and corresponding IP address of the ACU.

To start telnet session do as follows:

1. Open a Telnet client of your choice.
2. At the prompt, enter the IP address of the ACU, user name (admin) and password (1234).

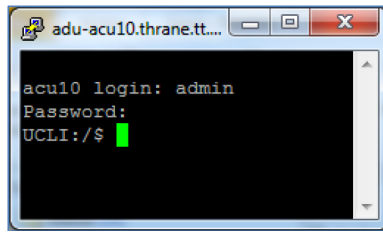

Figure D-2: Command line interface, login

## D.1.2 Help

If you enter **help** directly at the prompt **UCLI :/\$** all available commands are listed. Additionally any command will take **help** as first argument and display detailed information of the specific command.

## D.1.3 Conventions

The command description below uses the following special typography:

Convention	Description
Courier font	Information that is displayed on the screen.
<b>Bold Courier font</b>	Text the user must enter.
<argument>	Required argument
[argument]	Optional argument

Table D-1: Command typography

**Example:** `satellite lon [longitude]  
zone <id> active <yes | no>`



## D.2 Supported commands

The following commands are described in detail. They are listed in alphabetical order.

- *config*
- *demo*
- *dual\_antenna*
- *exit*
- *help*
- *modem*
- *satellite*
- *status*
- *system*
- *track*
- *zone*

### D.2.1 config

Command	Description
<b>config</b>	Shows the sub commands available, including a short description.
<b>config pending_list</b>	Shows the number of pending changes.
<b>config current_list</b>	Shows the values for the current satellite profile, antenna and some tracking information.
<b>config activate</b>	Use this command to save and activate the pending changes in the SAILOR 900 VSAT.

Table D-2: UCLI command: `config`

### D.2.2 demo

Command	Description
<b>demo start</b>	Starts a demo pattern where the antenna will turn azimuth, elevation and cross elevation until it receives the command <b>demo stop</b> .
<b>demo stop</b>	Stops the antenna demo pattern.
<b>demo reset</b>	Resets the antenna to angle 0.

Table D-3: UCLI command: `demo`

### D.2.3 dual\_antenna

Command	Description
<b>dual_antenna mode</b>	Shows the current dual antenna mode <ul style="list-style-type: none"> <li>• single</li> <li>• master</li> <li>• slave</li> </ul>
<b>dual_antenna status</b>	<ul style="list-style-type: none"> <li>• Shows the current dual-antenna mode status</li> <li>• active</li> <li>• inactive</li> </ul>

Table D-4: UCLI command: `dual_antenna`

### D.2.4 exit

Command	Description
<b>exit</b>	Exits the connection to the SAILOR 900 VSAT.

Table D-5: UCLI command: `exit`

### D.2.5 help

Command	Description
<b>help</b>	Shows a list of commands available, including a short description.
<b>help satellite</b>	Shows the sub commands and description for the command <code>satellite</code> .
<b>help modem</b>	Shows the sub commands and a short description for the command <code>modem</code> .
<b>help track</b>	Shows the sub commands and description for the command <code>track</code> .
<b>help status</b>	Shows the sub commands and description for the command <code>status</code> .
<b>help system</b>	Shows the sub commands and a short description for the command <code>system</code> .
<b>help config</b>	Shows the sub commands, unit and description for the command <code>config</code> .
<b>help zone</b>	Shows the sub commands, unit and description for the command <code>zone</code> .

Table D-6: UCLI command: `help`

## D.2.6 modem

Command	Description
<code>modem</code>	Shows a list of sub commands available, including a short description.
<code>modem name</code>	Shows the VSAT modem name of the currently active satellite profile (entered in the web interface).
<code>modem model</code>	Shows the currently active VSAT modem model (selected in the web interface).

Table D-7: UCLI command: `modem`

## D.2.7 satellite

Command	Description
<code>satellite name</code>	Shows the name of the currently active satellite profile.
<code>satellite lon</code> <code>satellite lon 1W</code>	Shows or sets the longitude position of the satellite, in degrees. <ul style="list-style-type: none"> <li>• 1.0W or 1.0E or -1.0 for west and 1.0 for east</li> </ul>
<code>satellite skew</code> <code>satellite skew 3.7</code>	Shows or sets an additional skew offset of the satellite. Some satellite has additional skew because they have been placed different in the orbit. E.g. Optus satellites in Australia are offset -45 degrees. Most satellites have 0 degree skew offset. <ul style="list-style-type: none"> <li>• Skew of the satellite: <math>-90^{\circ}</math> to <math>+90^{\circ}</math>.</li> </ul>
<code>satellite max_inc</code> <code>satellite max_inc 2.5</code>	Shows or sets the maximum inclination of the used satellite. Some satellites are old and are therefore moving in larger circles in space. Setting the maximum inclination will add this to the SAILOR 900 VSAT acquisition window size used to find the satellite. <ul style="list-style-type: none"> <li>• Maximum inclination of satellite <math>0.0^{\circ}</math> to <math>90^{\circ}</math></li> </ul>
<code>satellite rx_pol</code> <code>satellite rx_pol v</code>	Shows or sets the current RX polarisation: <ul style="list-style-type: none"> <li>• v (vertical)</li> <li>• h (horizontal)</li> </ul>

Table D-8: UCLI command: `satellite`

Command	Description
<pre>satellite tx_pol satellite tx_pol v</pre>	<p>Shows or sets the current RX polarisation:</p> <ul style="list-style-type: none"> <li>v (vertical)</li> <li>h (horizontal)</li> </ul>
<pre>satellite ele_cut_off satellite ele_cut_off 5</pre>	<p>Shows or sets the elevation referenced to earth where the SAILOR 900 VSAT must shut off for transmission. This is an FCC requirement. The elevation cut off depends on how much power is transmitted and which coding is used.</p> <ul style="list-style-type: none"> <li>Valid range: 0° to 90°</li> </ul> <p>For further information see <i>Elevation cutoff (in degrees) versus VSAT modem bandwidth and power</i> on page 6-21.</p>
<pre>satellite rx_lo</pre>	<p>Shows the Rx LO / LNB LO. Range: 9.6 GHz to 11.3 GHz.</p>
<pre>satellite rx_rf_freq satellite rx_rf_freq 12.123456 9.75</pre>	<p>Shows or sets the Ku-band rx frequency and LNB Lo frequency.</p> <ul style="list-style-type: none"> <li>RF frequency: 10.7 — 12.75 GHz.</li> <li>LNB Lo frequency: 9.6 GHz — 11.3 GHz.</li> </ul> <p>The SAILOR 900 VSAT supports any LNB Lo!</p> <p><b>Note:</b> Setting the Ku-band rx frequency and LNB Lo automatically configures the L-band rx frequency:  Rx L-band freq = rx_rf_freq – LNB Lo</p> <p><b>Example:</b> 1567.890 MHz = 11.567890 GHz – 10 GHz</p>
<pre>satellite rx_if_freq satellite rx_if_freq 1200.123 9.75</pre>	<p>Shows or sets the IF rx frequency together with the LNB Lo frequency.</p> <ul style="list-style-type: none"> <li>IF frequency within 950 MHz – 2150 MHz.</li> <li>LNB Lo frequency within 9.6 GHz – 11.3 GHz.</li> </ul> <p>The SAILOR 900 VSAT supports any LNB Lo!</p> <p><b>Note:</b> Setting the L-band rx frequency and LNB Lo automatically configures the Ku-band rx frequency:  Rx Ku-band frequency = LNB Lo + rx_if_frequency</p> <p><b>Example:</b> 11.567890 GHz = 10 GHz + 1567.890000 MHz</p>

Table D-8: UCLI command: **satellite** (Continued)

Command	Description
<code>satellite tx_lo</code>	Shows the current TX LO frequency, fixed at 12.8 GHz.
<code>satellite tx_rf_freq</code>  <code>satellite tx_rf_freq 14.123456</code>	Shows or sets the Set the RF frequency used for tx. <ul style="list-style-type: none"> <li>Valid range: 13.75 GHz to 14.5 GHz.</li> </ul> <p><b>Note:</b> Configuring the Ku-band tx frequency automatically configures the L-band frequency: L-band frequency = Ku-band tx frequency – 12.8 GHz (BUC Lo)</p> <p><b>Example:</b> 1308.300000 MHz = 14.108300 GHz – 12.8 GHz</p>
<code>satellite tx_if_freq</code>  <code>satellite tx_if_freq 1200.123</code>	Shows or sets the Set the IF frequency for tx. <ul style="list-style-type: none"> <li>Valid range: 950 MHz to 1700 MHz.</li> </ul> <p><b>Note:</b> Configuring the L-band tx frequency automatically configures the Ku-band frequency: Ku-band frequency = 12.8 GHz (BUC Lo) + L-band frequency</p> <p><b>Example:</b> 14.108300 GHz = 12.8 GHz + 1308.300000 MHz</p>

Table D-8: UCLI command: `satellite` (Continued)

## D.2.8 status

Command	Description
<code>status</code>	Shows the sub commands available, including a short description.
<code>status system</code>	Shows the current status of the SAILOR 900 VSAT. For further information on status values see <i>Information fields on the Dashboard</i> on page 6-16.
<code>status track_all</code>	Shows the current values for all tracking parameters: <ul style="list-style-type: none"> <li>vessel heading</li> <li>azimuth relative</li> <li>elevation relative</li> <li>polarisation skew</li> <li>GPS latitude and longitude</li> </ul>
<code>status event_list</code>	Shows a list of active events. For further information on events see <i>System messages</i> on page G-1.

Table D-9: UCLI command: `status`

## D.2.9 system

Command	Description
<code>system</code>	Shows the sub commands available, including a short description.
<code>system restart</code>	Sends a command to the ACU to restart the system instantaneously. It makes a power-on self test and then points to the last used satellite.
<code>system info</code>	Shows the software version, part names and serial numbers of the SAILOR 900 VSAT.

Table D-10: UCLI command: `system`

## D.2.10 track

Command	Description
<code>track</code>	Shows the sub commands available, including a short description.
<code>track mode</code> <code>track mode dvb</code>	Shows or sets the receiver bandwidth or mode, the way the SAILOR 900 VSAT tracks the satellite: <ul style="list-style-type: none"> <li>• narrow (recommended, uses the built-in 300 kHz filter of the SAILOR 900 VSAT)</li> <li>• rssi (uses the RSSI signal from the VSAT modem)</li> <li>• wide (uses the wide-band filter to track the satellite)</li> <li>• dvb (uses the built-in DVB-S2 receiver of the SAILOR 900 VSAT to track the satellite. You must configure <code>dvb_sym</code> and <code>dvb_nid</code>.)</li> </ul>
<code>track dvb_sym</code> <code>track dvb_sym 22</code>	Shows or sets the current mega symbols rate for the DVB-S2 receiver when in dvb mode. The symbol rate used to verify and track a transponder. <ul style="list-style-type: none"> <li>• Valid range: 0.1 — 99</li> </ul>
<code>track dvb_nid</code> <code>track dvb_nid 0</code>	Shows or sets the DVB NID to be verified by the built-in DVB-S2 tracking receiver, when using tracking mode DVB. It configures the NID used to verify and track a transponder. <ul style="list-style-type: none"> <li>• Valid range: 0 — 65535 A NID of '0' disables the NID check. Then the NID will be omitted in the verification of the transponder.</li> </ul>

Table D-11: UCLI command: `track`

Command	Description
<code>track rx_rf_freq</code>	<p>The frequency for the receiver to tune to. Verify that the frequency is in the same range as the modem <code>rx_rf_frequency</code>, above or below 11.7 GHz. If <code>rx_rf_freq</code> is set to 0, the tracking frequency is the same as the RX frequency provided by the modem</p> <ul style="list-style-type: none"> <li>Valid range: 10.7 GHz to 12.75 GHz.</li> </ul>

Table D-11: UCLI command: `track`

## D.2.11 zone

Command	Description
<code>zone</code>	Shows the sub commands, unit and description for the command <code>zone</code> .
<code>zone &lt;id&gt; azimuth &lt;start angle&gt; &lt;end angle&gt;</code>	<p>Sets the azimuth angles of the blocking zone for one zone.</p> <ul style="list-style-type: none"> <li>Valid zones: 0 to 7</li> <li>Valid angles: 0 to 360</li> </ul>
<code>zone &lt;id&gt; elevation &lt;start angle&gt; &lt;end angle&gt;</code>	<p>Sets the elevation angles for a blocking zone.</p> <ul style="list-style-type: none"> <li>Valid zones: 0 to 7</li> <li>Valid angles: 0 to 360</li> </ul>
<code>zone &lt;id&gt; tx_off &lt;yes   no&gt;</code>	Enables or disables TX inside the blocking zone.
<code>zone &lt;id&gt; active &lt;yes   no&gt;</code>	Enables or disables the blocking zone.
<code>zone &lt;id&gt;</code>	Shows the setting for the blocking zone.

Table D-12: UCLI command: `zone`





# DVB-S satellites

This appendix contains examples of DVB-S satellite data for azimuth calibration of the SAILOR 900 VSAT.







VSAT coverage	Satellite name	Satellite position	RX polarisation	RX frequency	Symbol rate	NID
<b>Americas</b> 	<b>SatMex6</b> Transponder Backup	113°W	Horizontal —	12.080 GHz —	25.635 MS/s —	0 —
<b>USA</b> 	<b>Echostar9</b> Transponder Backup	121°W	Horizontal Vertical	11.943 GHz 12.016 GHz	20.000 MS/s 20.000 MS/s	4106 4106
<b>South East Asia</b> 	<b>NSS6</b> Transponder Backup	95°E	Horizontal Horizontal	11.676 GHz 12.729 GHz	27.500 MS/s 26.400 MS/s	6553 5 100
<b>Europe</b> 	<b>Thor 5 T2</b> Transponder Backup	0.8°W	Horizontal Vertical	11.785 GHz 12.418 GHz	30.000 MS/s 28.000 MS/s	70 70
<b>Europe</b> 	<b>Telstar 11N</b> Transponder	37,5°W	Horizontal	11.658 GHz	5.9 MS/s	0
<b>Europe</b> 	<b>Astra2</b> Transponder Backup	28.2°E	Horizontal Horizontal	11.623 GHz 12.032 GHz	27.500 MS/s 27.500 MS/s	32 2

Table E-1: Examples of DVB-S satellites for azimuth calibration

VSAT coverage	Satellite name	Satellite position	RX polarisation	RX frequency	Symbol rate	NID
<b>China</b> 	<b>Apstar6</b>	134°E	Horizontal	12.435 GHz	27.500 MS/s	65
			Vertical	12.675 GHz	27.500 MS/s	65
<b>Australia</b> 	<b>Optus D1</b>	160°E -45°skew	Horizontal	12.391 GHz	12.600 MS/s	0
			Horizontal	12.407 GHz	12.600 MS/s	0
<b>Singapore</b>	<b>Thaicom 5</b>	78.5°E	Horizontal	12.272 GHz	30.000 MS/s	88
			Vertical	12.313 GHz	30.000 MS/s	1
<b>Singapore</b>	<b>Apstar 2R (Telstar 10) / Apstar 7</b>	76.5°E	Vertical	11.167 GHz	45.000 MS/s	0

Table E-1: Examples of DVB-S satellites for azimuth calibration (Continued)

For satellite data of other regions or transponders see [www.lyngsat.com](http://www.lyngsat.com).

**Example:**

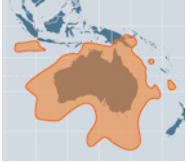

Freq. Tp	Provider Name	Channel Name	System Encryption	SR-FEC	ONID-TID	Beam EIRP (dBW)	Source Updated
11038 V tp 38		Canal +		DVB-S Mediaguard 2 Nagravision 3	22000-5/6	1-1038 Europe 51 6.5	D Shimoni 111119

Figure E-1: Satellite data, example from [www.lyngsat.com](http://www.lyngsat.com)

The above transponder has following parameters:

- Frequency: 11.038 GHz
- Polarisation: V-Vertical
- Symbol Rate: 22.000 MS/s
- NID: 1
- Coverage: Europe.

# Grounding and RF protection

## F.1 Why is grounding required?

### F.1.1 Reasons for grounding

Grounding the SAILOR 900 VSAT system is required for at least two reasons:

- Safety: Lightning protection of persons and equipment.
- Protection: ESD (ElectroStatic Discharge) protection of equipment.

### F.1.2 Safety

First of all grounding of the system is required for safety reasons. In the event of a lightning strike at the ADU a proper grounding of the system will provide a low resistance path to divert the strike discharge to seawater.

### F.1.3 ESD Protection

The ESD protection circuits in the ACU rely on proper grounding of the system in order to work properly. Otherwise sensitive circuits within the ACU might be damaged due to ESD when you are handling the equipment.

## F.2 Grounding Recommendations

### F.2.1 Grounding the ACU

The ACU should be grounded to the ship/hull. For this purpose you may use a short ADU cable and a grounding kit. Further, the ACU must be grounded at its grounding stud in order to ensure proper grounding if the short ADU cable is disconnected. For further information, see *Grounding the terminal* on page 2-33.

If you use the Extended cable support, make the ground connections through the cable support. You may need to extend the ground plane using copper foil, see the following section.

#### Extending the ground plane

In some cases it may not be possible to access the hull and at the same time place the ACU in a suitable place. A way to insure good grounding and at the same time make it possible to ground the coax cable - is to extend the ship ground plane by means of copper foil. The maximum length of the foil is determined by the width of the foil:

Copper foil 5 cm wide: Max 50 cm

Copper foil 10 cm wide: Max 100 cm

Copper foil 20 cm wide: Max 200 cm

**Note** The foil must be at least 0.1 mm thick.

Connect the foil to the hull by plenty of screws or hard-soldering. Run the foil past the place where the short ADU cable is to be grounded and mount a grounding kit on top of the foil. For details on the jumper cable see *Jumper cable for grounding* on page F-10.

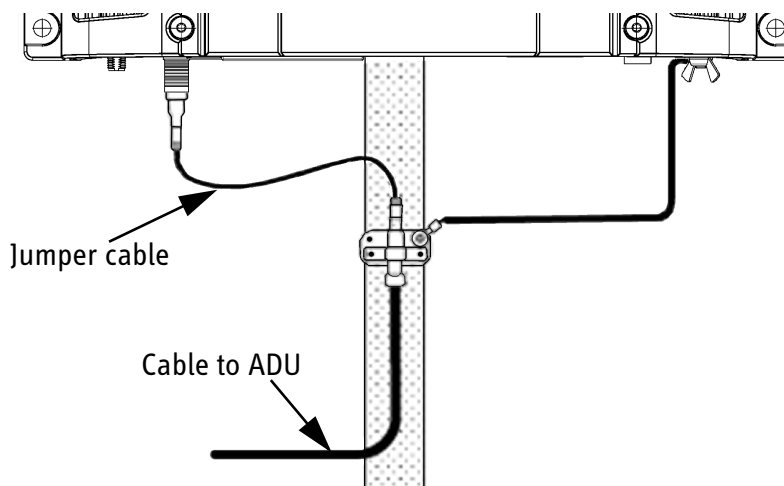

Figure F-1: Extending the ground plane

### F.2.2 Grounding the ADU

You can ground the ADU to the ship/hull via one or more of its mounting bolts. Make sure to remove painting, dirt, grease etc. at the mounting holes in order to make good electrical

contact to the hull. Use serrated washers when securing the mounting bolts and seal the joint with protective coating to avoid corrosion.

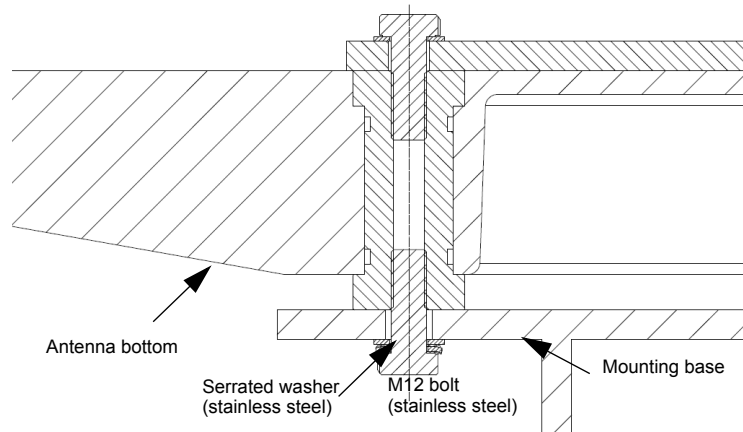

Figure F-2: Grounding the ADU

**Note** For optimum grounding use the mounting bolt located closest to the ADU cable plate, see Figure 3-21: *ADU, bolt for optimum grounding* on page 3-21.

It is always recommended to establish the shortest possible grounding path e.g. on steel hulls the ADU should be grounded directly to the hull<sup>1</sup>. However, due to the fact that this is not possible on e.g. fibreglass hulls (nor is it preferable on aluminium hulls) a number of alternative grounding methods are suggested in the following paragraphs.

## F.3 Alternative grounding for steel hulls

The following guidelines assume a two-wire, isolated grounding arrangement; that is no part of the circuit, in particular the battery negative, is connected to any ground potential or equipment.

### F.3.1 Grounding the ACU

The ACU should preferably be grounded to the ship with the short cable. Further, the ACU must be grounded at its grounding stud in order to ensure a proper grounding if the short ADU cable is disconnected.

The ground connection can be established either at the hull (recommended) or at a dedicated RF ground if available (alternative).

**Important** However, bear in mind that the ADU ground connection is to be made at the **same electrical ground potential as the ACU** (see *Grounding the ADU*).

1. Please note that the ADU ground connection is made at the same electrical ground potential as the ACU.

The ACU provides galvanic isolation (as required) from its input power terminals to the chassis/grounding stud. This way the isolated grounding arrangement is maintained.

### F.3.2 Grounding the ADU

**Note** For optimum grounding use the mounting bolt located closest to the ADU cable plate, see Figure 3-21: *ADU, bolt for optimum grounding* on page 3-21.

#### Terminal grounded at the hull (recommended)

In this case the ADU is grounded to the ship via one (or more) of its mounting bolts. Make sure to remove painting, dirt, grease etc. at the mounting holes in order to make good electrical contact to the hull. Use serrated washers when securing the mounting bolts and seal the joint with protective coating to avoid corrosion.

#### Terminal grounded at a dedicated RF ground (alternative)

In this case the ADU is grounded with a separate ground cable. The ground cable must be routed parallel and close to the shielded coax cable connecting the ADU to the ACU grounding kit. A heavy gauge wire with tinned strands (min. 6 mm<sup>2</sup>) can be used for this purpose.

**Note** The ADU must be electrically isolated at its mounting bolts by means of shoulder bushings and washers ensuring the isolated RF ground - see *Isolation of the ADU from the mounting base* on page F-8.

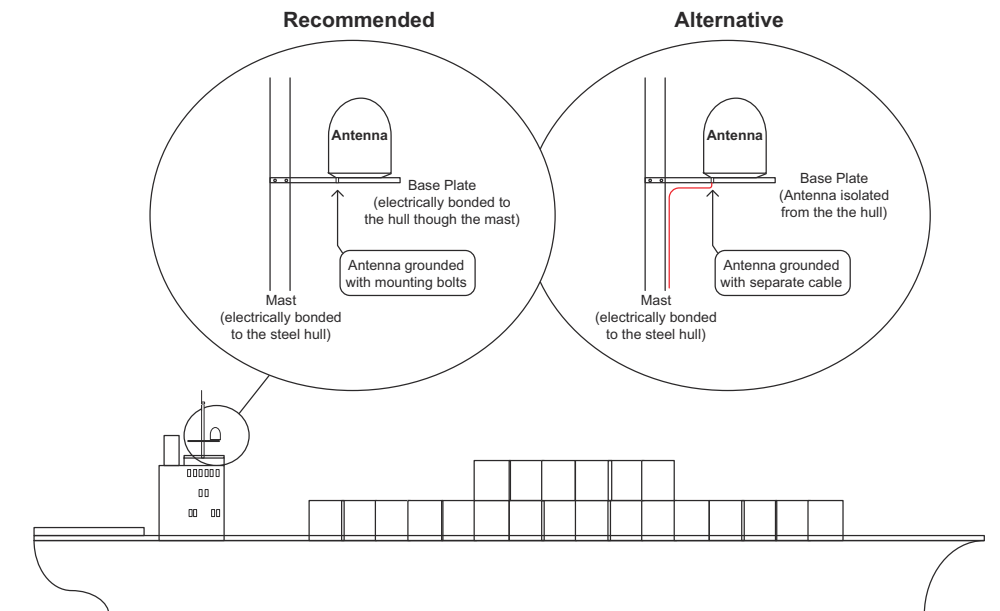

Figure F-3: Grounding at a dedicated RF ground (alternative)

## F.4 Alternative grounding for aluminum hulls

The following guidelines assume a two-wire, isolated grounding arrangement; that is no part of the circuit, in particular the battery negative, is connected to any ground potential or equipment.

### F.4.1 Grounding the ACU

The ACU should preferably be grounded with the short cable. Further, the ACU must be grounded at its grounding stud to ensure a proper grounding if the short ADU cable is disconnected.

The ground connection must be established at a dedicated RF ground (either capacitively or electrically coupled).

**Important** Remember to make the ADU ground connection at the **same electrical ground potential** as the ACU (see *Grounding the ADU*).

The ACU provides galvanic isolation (as required) from its input power terminals to the chassis/grounding stud. This way the isolated grounding arrangement is maintained.

### F.4.2 Grounding the ADU

If the mounting base of the ADU is electrically connected to the hull (or any other ground potential than the ACU), the ADU must be isolated at its mounting bolts by means of shoulder bushings and washers, see F.6.3. This is done in order to prevent DC currents flowing in the hull thus causing electrolytic corrosion.

However, a ground connection must be established via one of the mounting bolts using a separate ground cable. The ground cable must be routed parallel and in close proximity to the shielded ground coax cable hence connecting the ADU to the ACU Grounding kit. A heavy gauge wire with tinned strands (min. 6 mm<sup>2</sup>) can be used for this purpose.

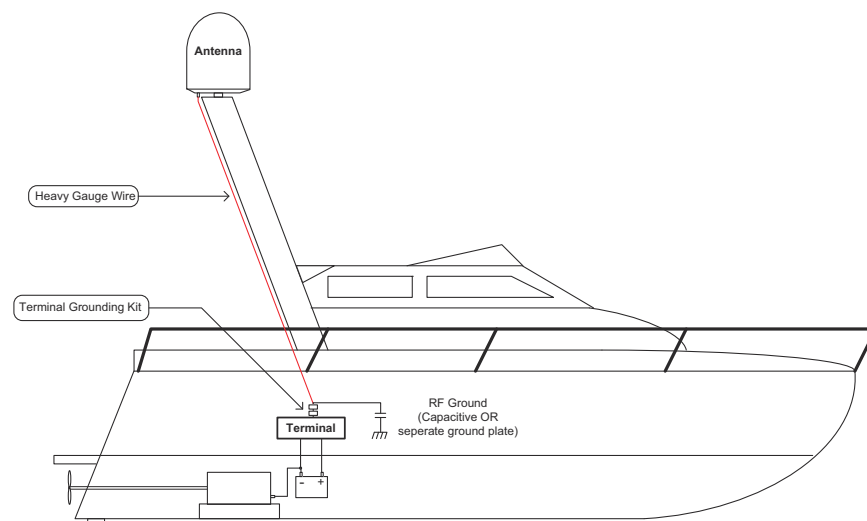

Figure F-4: Alternative grounding for aluminium hulls

## F.5 Alternative grounding for fibre glass hulls

### F.5.1 Grounding the ACU

The ACU should preferably be grounded with the short ADU cable and a grounding kit (available from Thrane & Thrane). Further, the ACU must be grounded at its grounding stud in order to ensure a proper grounding if the short ADU cable is disconnected.

The ground connection must be established at a dedicated RF ground (either capacitive or electrical coupled).

#### Important

Bear in mind that the ADU ground connection is to be made at the **same electrical ground potential** as the ACU (see *Grounding the ADU*).

### F.5.2 Grounding the ADU

If the mounting base of the ADU is electrically connected to any other ground potential than the ACU (e.g. Lightning Ground), the ADU must be isolated at its mounting bolts by means of shoulder bushings and washers - see section F.6.3.

However, a ground connection must be established via one of the mounting bolts using a separate ground cable. The ground cable must be routed parallel and in close proximity to the shielded coax cable hence connecting the ADU to the ACU Grounding kit. A heavy gauge wire with tinned strands (min. 6 mm<sup>2</sup>) can be used for this purpose.

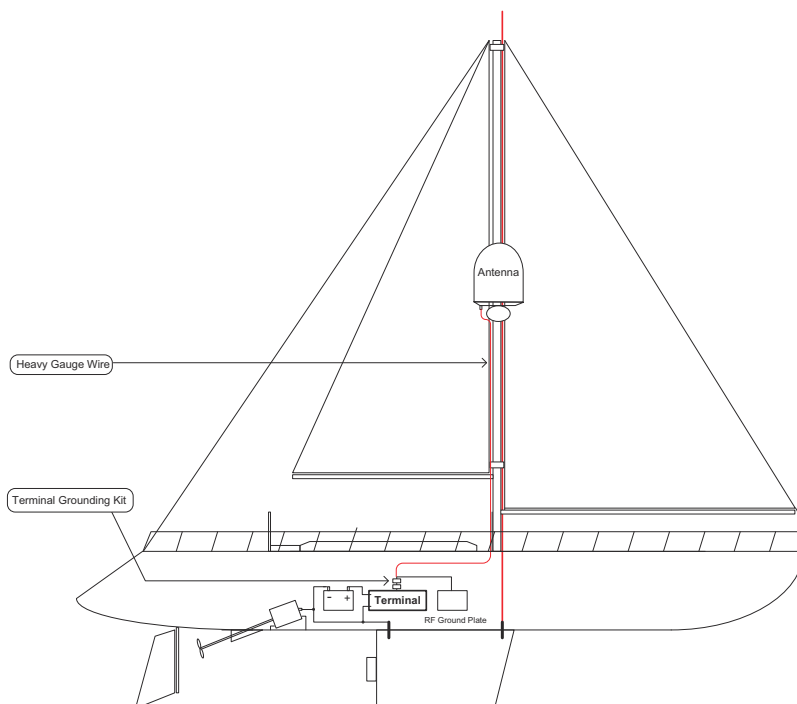

Figure F-5: Alternative grounding for fibreglass hulls



## F.6 Separate ground cable

### F.6.1 Ground cable - construction

When dealing with electrical installations in a marine environment, all wiring must be done with double insulated, tinned strands, high quality and if exposed also UV resistant cables. This shall also apply to the separate ground cable mentioned in the previous paragraphs.

The ground cable is constructed using an appropriate cable with a cross section area of at least  $6 \text{ mm}^2$  (AWG10) and terminated with insulated ring crimp terminals – see illustration below. The crimp terminals must be a marine approved type e.g. the DuraSeal series from Raychem.

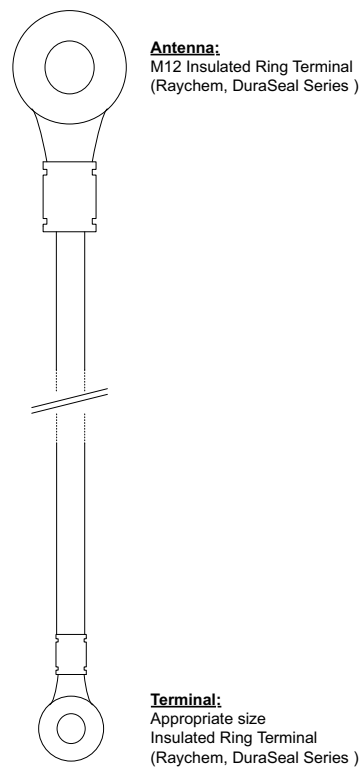

Figure F-6: Separate ground cable

### F.6.2 Ground cable - connection

Mount the ground cable close to and parallel to the shielded coax cable thus minimizing ground loop problems. If possible, route the coax cable and the ground cable in metal conduits bonded to the hull or within a mast (depending on the actual installation).

The ground cable must be connected at one of the mounting/grounding bolts on the ADU. Use bolts and washers of stainless steel and seal the joint with protective coating to avoid corrosion. If the ADU is to be isolated from the mounting base, shoulder bushings and washers must be used — see figure F-7, *Isolation of the ADU from the mounting base* on page F-8.

At the other end, connect the ground cable as described in *Grounding the ACU* on page F-2.

### F.6.3 Isolation of the ADU from the mounting base

In cases where the ADU is to be isolated from the mounting base, shoulder bushings and washers (accessories) must be used as illustrated below. Please note that the isolation has to be implemented on all four mounting bolts (including the bolt securing the ground cable).

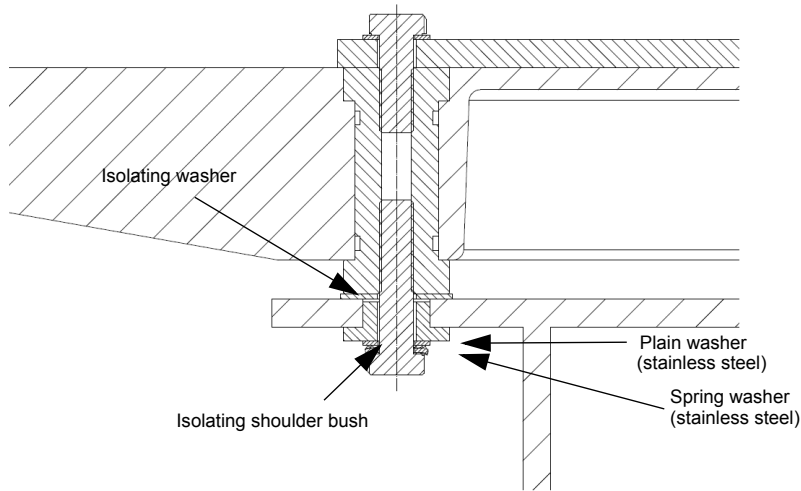

Figure F-7: Isolation of the ADU from the mounting base

The ground cable must be connected at one of the mounting/grounding bolts on the ADU as illustrated below. Remember to seal the joint with protective coating to avoid corrosion.

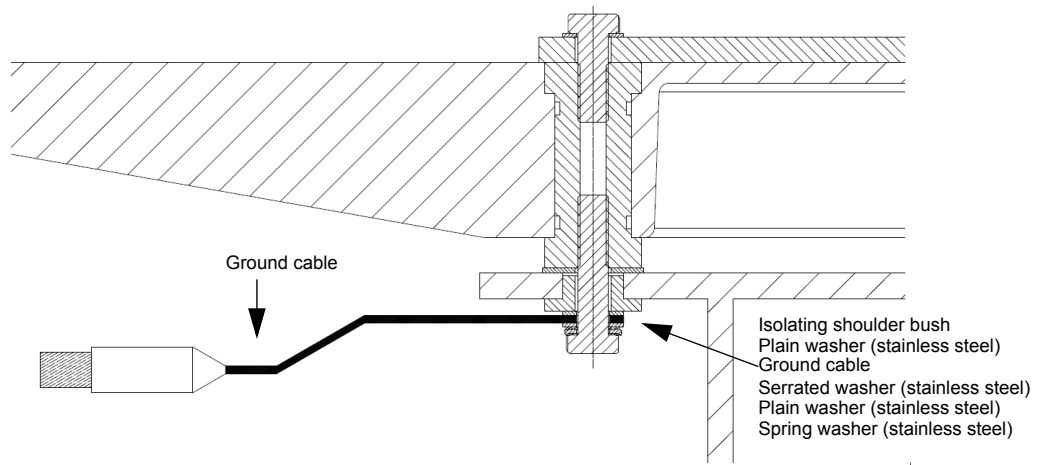

Figure F-8: ADU isolation and grounding cable

# F.7 Jumper cable for grounding

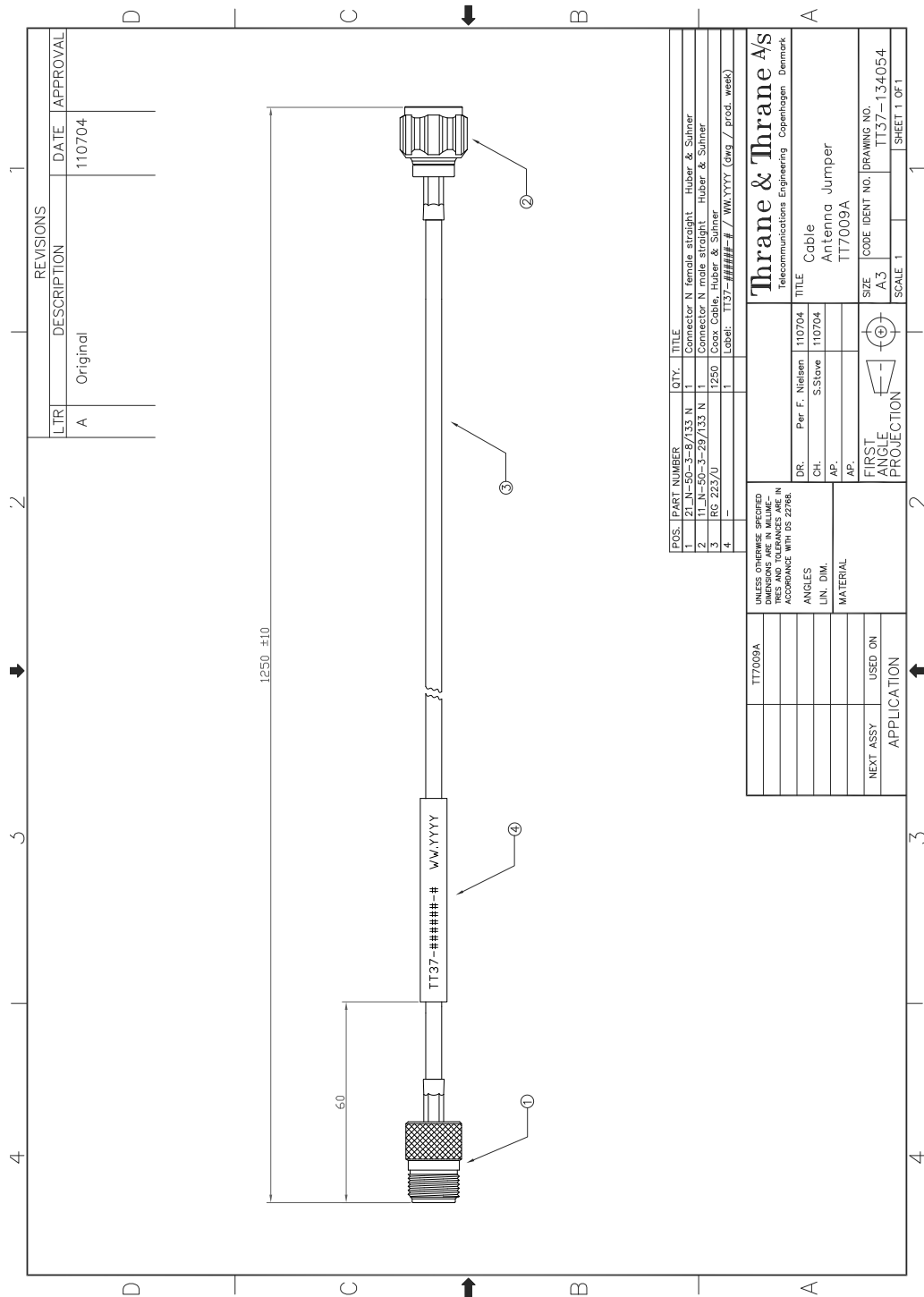

Figure F-9: Jumper cable for grounding (specifications)

## **F.8 RF interference**

Interference induced from nearby high-power RF transmitters might cause system failures and in extreme cases permanent damage to the SAILOR 900 VSAT equipment. If there are problems with interference from HF transmitters, it is advisable to mount ferrite clamps on the coax cable in order to provide suppression of induced RF. The ferrites will have no effect on the differential-mode signals but increases the impedance in relation to common-mode RFI.

### **F.8.1 Recommendations**

Use 1-5 pcs. hinged clamp cores (e.g. the RFC or SFC series from Kitagawa) mounted on the ADU cable near the ADU.



# System messages

## G.1 Event messages – overview

The SAILOR 900 VSAT detects events during

- POST (Power On Self Test) – a self test performed at every power-up.
- PAST (Person Activated Self test) – started in the web interface
- CM (Continuous Monitoring) – automatically performed while the system is in operation.

When the SAILOR 900 VSAT detects an event that requires your action, it issues an event message and the red Fail/Pass LED in the LED panel of the ACU is lit. As long as an event is active, it is shown in the ACU display and the web interface (in HELPDESK > Event list or click the event icon on the DASHBOARD).

**Note**

Active events and notifications are shown. As soon as the event is cleared, it is not displayed any longer. It is then moved to the Notifications section. Notifications are cleared after 24 hours.

State the Event ID when contacting your service partner.

The event description might contain a number of digits in brackets, e.g. (00000005). This is supplemental information and used for service and diagnostics purposes.

## G.2 List of ADU events

Error code (ID)	Unit	Severity	Description	Explanation
0A001-0	Antenna	ERROR	Production data	Production data is invalid.
0A002-0	Antenna	ERROR	XIM internal	Antenna configuration data stored in the PCM module is invalid.
0A003-0	Antenna	ERROR	XIM external	Antenna configuration data stored in the VIM/TIM module is invalid.
0A004-0	Antenna	ERROR	XIM I/X match	Antenna configuration data stored in the PCM module does not match the configuration data stored in the VIM/TIM module.
0A005-0	Antenna	ERROR	Antenna type	The configured antenna type is not supported or unknown.
0A006-0	Antenna	ERROR	PCM FPGA load	The PCM FPGA cannot be initialised and loaded correctly.
0A007-0	Antenna	ERROR	XIM FPGA load	The VIM/TIM FPGA cannot be initialised and loaded correctly.
0A008-0	Antenna	ERROR	XIM production	Production/calibration data stored in the VIM/TIM module is invalid.
0A00A-0	Antenna	ERROR	GPS initialisation	The GNSS device cannot be initialised. Check cable and GNSS device.
0A014-0	Antenna	ERROR	AMB device discovery	Missing one or more of the following devices: ISM, DDM and PMM. Check cables.
0A015-0	Antenna	ERROR	Azi DDM ABS device	Cannot initialise the azimuth DDM. Info: 0x00000000: Device not found (possible cabling problem) 0x0000bbaa: Device internal error (replace device) aa=status, bb=state.
0A016-0	Antenna	ERROR	Xel DDM ABS device	Cannot initialise the cross-elevation DDM. Info: See 0A015-0.
0A017-0	Antenna	ERROR	Ele DDM ABS device	Cannot initialise the elevation DDM. Info: See 0A015-0.

Table G-1: ADU event messages



Error code (ID)	Unit	Severity	Description	Explanation
0A018-0	Antenna	ERROR	ISM ABS device	Cannot initialise the ISM Info: 0x00000000: Device not found (possible cabling problem) 0x000cbbaa: Device internal error (replace device) aa=status, bb=state, c=calibration data error.
0A019-0	Antenna	ERROR	PMM ABS device	Cannot initialise the PMM. Info: See 0A015-0.
0A01E-0	Antenna	ERROR	Sensor sanity	Too many invalid values measured by the ISM during initialisation. Check for vibrations or malfunctioning ISM.
0A021-0	Antenna	ERROR	Azi axis calibration	Azimuth axis zero reference not found. Check belt and zero reference module. Info: 0x00000001: Timeout (operation did not complete in time) 0x00000010: Encoder or mechanical problem 0x00000020: Zero reference not found 0x00000040: End stop not found.
0A022-0	Antenna	ERROR	Xel axis calibration	Cross-elevation axis zero reference or end stops not found at expected locations. Check belt, zero reference module, and end stops. Info: See 0A021-0.
0A023-0	Antenna	ERROR	Ele axis calibration	Elevation axis zero reference or end stops not found at expected locations. Check belt, zero reference module, and end stops. Info: See 0A021-0.
0A024-0	Antenna	ERROR	Pol axis calibration	Polarisation axis zero reference or end stops not found at expected locations. Check movement of the polarisation unit and the zero reference module. Info: See 0A021-0.
0A025-0	Antenna	ERROR	Antenna calibration	One or more errors occurred during antenna start-up Info: 0x00000001: Timeout (calibration did not complete in time) 0x00000010: Azimuth axis 0x00000020: Cross-elevation axis 0x00000040: Elevation axis 0x00000080: Polarisation axis
0A028-0	Antenna	ERROR	Demodulator load	The second receiver demodulator cannot be initialised and loaded correctly.
0A029-0	Antenna	ERROR	XIM PLL lock	The PLL on the VIM/TIM does not lock.

Table G-1: ADU event messages (Continued)

Error code (ID)	Unit	Severity	Description	Explanation
0A02B-0	Antenna	ERROR	ABS software version	The ABS software version in the antenna is too old to match the hardware requirements. Upgrade the software.
0A034-0	Antenna	WARNING	ACU communication	The communication link between ACU and antenna is down.
0A035-0	Antenna	WARNING	ISM data valid	Sensor measurements from the ISM are invalid. This indicates a malfunctioning ISM.
0A036-0	Antenna	WARNING	ISM data range	Sensor measurements from the ISM are out of range.
0A037-0	Antenna	WARNING	GNSS communication	Lost connection to the GNSS device.
0A038-0	Antenna	WARNING	GNSS data range	Received information from the GNSS device which is out of range.
0A039-0	Antenna	WARNING	GNSS device warning	Local GNSS device warning.
0A03A-0	Antenna	WARNING	GNSS device error	Local GNSS device error.
0A03B-0	Antenna	ERROR	Azi DDM shutdown	The azimuth motor control has detected one of the following situations: Extreme temperature, voltage, current or velocity. The motor was then shut down. This is usually a temporary situation and is probably fixed by a restart of the system.
0A03C-0	Antenna	ERROR	Xel DDM shutdown	As Azi DDM shutdown but detected by the cross-elevation motor control.
0A03D-0	Antenna	ERROR	Ele DDM shutdown	As Azi DDM shutdown but detected by the elevation motor control.
0A03E-0	Antenna	ERROR	PMM shutdown	As Azi DDM shutdown but detected by the polarisation motor control.
0A03F-0	Antenna	WARNING	AMB timing	This indicates a busy situation. It may occur during installation procedures. No user interaction is required.
0A040-0	Antenna	WARNING	VIM cable attn	The output power cannot be controlled correctly. Check the Tx chain.
0A041-0	Antenna	WARNING	BUC voltage low	The voltage for the BUC is too low, probably caused by a malfunctioning VIM or BUC.

Table G-1: ADU event messages (Continued)

Error code (ID)	Unit	Severity	Description	Explanation
0A042-0	Antenna	WARNING	BUC voltage high	The voltage for the BUC is too high probably caused by a malfunctioning VIM.
0A043-0	Antenna	WARNING	LNB voltage low	The voltage for the LNB is too low probably caused by a malfunctioning VIM/TIM or LNB.
0A044-0	Antenna	WARNING	LNB voltage high	The voltage for the LNB is too high probably caused by a malfunctioning VIM/TIM.
0A045-0	Antenna	WARNING	PMM fan	The fan is not working or the tacho input from the fan is not connected. Check fan cable and fan.
0A046-0	Antenna	WARNING	OMT temperature	The temperature of the BUC is too high. Check if the fan is working.
0A047-0	Antenna	ERROR	VIM PLL lock	The PLL of the VIM/TIM is out of lock. Check the 10 MHz reference signal.
0A048-0	Antenna	WARNING	VIM tuner lock	The PLL of the second receiver (DVB) is out of lock. Check the 10 MHz reference signal.
0A049-0	Antenna	WARNING	Azi encoder slip	A slip of the azimuth encoder has been detected. No user interaction is required unless this is a permanent situation. In this case the belt and encoder of the azimuth axis must be checked.
0A04A-0	Antenna	WARNING	Xel encoder slip	A slip of the cross-elevation encoder has been detected. No user interaction is required unless this is a permanent situation. In this case the belt and encoder of the cross-elevation axis must be checked.
0A04B-0	Antenna	WARNING	Ele encoder slip	A slip of the elevation encoder has been detected. No user interaction is required unless this is a permanent situation. In this case the belt and encoder of the elevation axis must be checked.
0A04C-0	Antenna	WARNING	Pol encoder slip	A slip of the polarisation encoder has been detected. No user interaction is required unless this is a permanent situation in which case the encoder of the polarisation axis must be checked.
0A04D-0	Antenna	WARNING	GNSS position	No position available from the GNSS device or position too old.
0A04E-0	Antenna	WARNING	GNSS velocity	No velocity available from the GNSS device.
0A04F-0	Antenna	ERROR	Heading data	Heading information is missing in the antenna.

Table G-1: ADU event messages (Continued)

Error code (ID)	Unit	Severity	Description	Explanation
0A050-0	Antenna	ERROR	Azi DDM communication	Communication error between PCM and azimuth DDM. Check SUB-D connectors and cables.
0A051-0	Antenna	ERROR	Xel DDM communication	Communication error between PCM and cross-elevation DDM. Check SUB-D connectors and cables.
0A052-0	Antenna	ERROR	Ele DDM communication	Communication error between PCM and elevation DDM. Check SUB-D connectors and cables
0A053-0	Antenna	ERROR	ISM communication	Communication error between PCM and ISM. Check SUB-D connectors and cables.
0A054-0	Antenna	ERROR	PMM communication	Communication error between PCM and PMM. Check SUB-D connectors and cables.
0A055-0	Antenna	WARNING	Azi DDM warning	The azimuth motor controller has temporarily observed an unusual situation with regards to temperature, voltage, current or velocity. No user interaction required.
0A056-0	Antenna	WARNING	Xel DDM warning	The cross-elevation motor controller has temporarily observed an unusual situation with regards to temperature, voltage, current or velocity. No user interaction required.
0A057-0	Antenna	WARNING	Ele DDM warning	The elevation motor controller has temporarily observed an unusual situation with regards to temperature, voltage, current or velocity. No user interaction required.
0A058-0	Antenna	WARNING	PMM warning	The polarisation motor controller has temporarily observed an unusual situation with regards to temperature, voltage, current or velocity. No user interaction required.

Table G-1: ADU event messages (Continued)

Error code (ID)	Unit	Severity	Description	Explanation
0A059-0	Antenna	WARNING	Azi cal. limits	Azimuth axis calibration result check limits exceeded. Pointing performance may be degraded. Info: 0x00000040: End stop detected before expected limit 0x00000100: Zero width is low 0x00000200: Zero width is high 0x00000400: Zero slack is high 0x00001000: Friction average is high 0x00002000: Friction peak is high 0x00004000: Friction asymmetry is high Zero width low/high: Zero reference module placement may be incorrect. Zero slack high: Mechanical slack may be too high. Friction average/peak high: Mechanical friction is higher than expected. Friction asymmetry high: Mechanical imbalance may be too high.
0A05A-0	Antenna	WARNING	Xel cal. limits	Cross-elevation axis calibration result check limits exceeded. Pointing performance may be degraded. Info: See 0A059-0.
0A05B-0	Antenna	WARNING	Ele cal. limits	Elevation axis calibration result check limits exceeded. Pointing performance may be degraded. Info: See 0A059-0.
0A05C-0	Antenna	WARNING	Pol cal. limits	Polarisation axis calibration result check limits exceeded. Pointing performance may be degraded. Info: See 0A059-0.
0A05D-0	Antenna	WARNING	ISM warning	The ISM has temporarily observed an unusual situation with regards to temperature or voltage. No user interaction required. If repeated after cooldown and reboot, the ISM or cables around it may be defective.
0A05E-0	Antenna	WARNING	Low elevation	The antenna is not allowed to transmit because the elevation is too low.
0A05F-0	Antenna	WARNING	Heading range	Heading data range error. External heading unit supplies unreliable data.

Table G-1: ADU event messages (Continued)

## G.3 List of ACU events

Error code (ID)	ACU PCB	Severity	Description	Explanation
08060-0	ADM	WARNING	ADU modem	ACU/ADU communication error detected (framing and parity). If the situation is persistent, check if cable specifications comply (length and attenuation).
08061-0	ADM	WARNING	VMU linux shell password	The specified password (root) for the VSAT modem is not accepted by the modem.
08062-0	ADM	WARNING	VMU debug shell password	The specified password (user) for the VSAT modem is not accepted by the modem.
08063-0	ADM	ERROR	ADU connection	The ACU has lost connection with the antenna.
08064-0	ADM	ERROR	ADM PLL lock	The intermediate frequency PLL is not in lock. Check the 10 MHz reference signal.
08065-0	ADM	WARNING	GNSS data	Missing GPS data (fix).
08066-0	ADM	WARNING	Heading data	Missing heading information. Check cable and heading provider device.
08067-0	ADM	ERROR	PCB temperature	ADM temperature too high. The ACU is not equipped with a fan, so make sure there is compliance with the environmental specifications.
08068-0	ADM	ERROR	PSM power	The PSM fails to provide the requested supply voltage.
08069-0	ADM	WARNING	Blocking Zone	The antenna has entered a blocking zone.
0806A-0	ADM	WARNING	VMU connection	The ACU has lost connection with the VSAT modem.
0806B-0	ADM	WARNING	ROSS connection	The ACU has lost connection with the ROSS device.
0806C-0	ADM	ERROR	VMU frequency setup	There is a mismatch in the frequency setup. Probably the VSAT modem is not configured correctly to match the requirements of the ACU and antenna. A common mismatch is the absence of Rx or Tx LO parameter in the VSAT modem.

Table G-2: ACU event messages

Error code (ID)	ACU PCB	Severity	Description	Explanation
0806D-0	ADM	ERROR	ADU power	The ADU supply voltage is outside the allowed limits. This could happen if the PSM fails to provide the requested supply voltage or if the voltage difference across the hotswap is unacceptable high.
0806E-0	ADM	ERROR	VMU 10 MHz reference	The VMU 10 MHz Rx or Tx reference signal is not present. Whether this error Rx or Tx reference, depends on the users selection on the modem profile page. Make sure VMU Rx/Tx cable is connected and that the VMU is configured to output the RX/TX 10 MHz reference signal.
0806F-0	ADM	ERROR	ROSS synchronization	The ACU has become out of sync with the ROSS device, most likely because the ACU has been replaced, or the ROSS satellite profile is new. A manual (forced) handoff sequence must be initiated from the ROSS, refer to the ROSS manual for the procedure.
08073-0	ADM	WARNING	Slave connection	The system is configured as a dual antenna master, but no dual antenna slave is connected to it. Either disable the dual antenna master in the web interface or configure a another system as a dual antenna slave.
08074-0	ADM	WARNING	Master connection	The system is configured as a dual antenna slave, but it was not possible to connect to the dual antenna master. Check that the IP address entered in the modem profile is correct and check that the master and slave systems are physically connected as described in the manual.
08076-0	ADM	WARNING	Incompatible message version	The system is configured as a dual antenna system, but the software versions on master and slave system are different. Ensure that both master and slave have identical software.
08100-0	ADM	ERROR	PSM low voltage (22 V)	The ADM measures a different ADU voltage than expected. If the problem is not solved by a restart, and the PSM is not reporting any errors, the ADM is probably defective.

Table G-2: ACU event messages (Continued)

Error code (ID)	ACU PCB	Severity	Description	Explanation
08101-0	ADM	ERROR	PSM high voltage (48 V)	The ADM measures a different ADU voltage than expected. Check for short circuit of the antenna coax connector. If the problem is not solved by a restart, and the PSM is not reporting any errors, the ADM is probably defective.
08102-0	ADM	ERROR	PSM 5 V power	Internal voltage supply error of the ADM.
08103-0	ADM	ERROR	ADM hotswap	The ACU is not able to supply the correct voltage to the antenna. Check for short circuits in coax cable and the antenna
08104-0	ADM	ERROR	ADU communication	The ACU cannot communicate with the antenna. Check cable and antenna.
08107-0	ADM	ERROR	ADM FPGA load	The ADM FPGA cannot be initialised and loaded.
08108-0	ADM	ERROR	TX Power Detector calibration	The Tx power detector calibration is not valid.
08109-0	ADM	ERROR	ADU XIM data	There is a mismatch with the antenna configuration data. Either the PCM or the VIM in the antenna are malfunctioning or one of them has been replaced. In the latter case, select which is the original device in the web interface and restart the system.
0810A-0	ADM	ERROR	ADM production data	Production data has been corrupted.
0810B-0	ADM	ERROR	ADU software version	Some error occurred during upload of software to the ADU, which means that the ADU software version is not as expected. Either the software in the ACU, does not meet the minimum version required by the ADU, the software image in the ACU is corrupted or the upload procedure failed because of a communication error.
0810C-0	ADM	ERROR	File system integrity	One or more file system partitions are corrupt. You may have lost your settings and collected statistics. If restarting the system does not help, contact your service partner.
09000-0	KDM	ERROR	KDM 3V3 supply	Internal 3V3 voltage supply error in the KDM.
09001-0	KDM	ERROR	KDM 12V supply	Internal 12V voltage supply error in the KDM.

Table G-2: ACU event messages (Continued)



Error code (ID)	ACU PCB	Severity	Description	Explanation
09002-0	KDM	ERROR	KDM display	Display hardware error in the KDM.
09010-0	KDM	ERROR	KDM link/SW version	Link to the KDM module could not be established. Either the KDM board is malfunctioning, or - if the system software has just been updated - the software is too old and is not compatible with the KDM hardware.
0B000-0	PSM	ERROR	PSM production data	Missing or invalid production data in the PSM. It should be replaced.
0B001-0	PSM	ERROR	NMEA 2000 identifier	Missing or invalid production data in the PSM. It should be replaced.
0B010-0	PSM	ERROR	PSM link/SW version	Link to the PSM module could not be established. Either the PSM board is malfunctioning, or - if the system software has just been updated - the software is too old and is not compatible with the PSM hardware.
0B060-0	PSM	WARNING	NMEA 0183 parse error	Parse errors detected on the NMEA 0183 interface. Check NMEA 0183 cable, signal levels etc.

Table G-2: ACU event messages (Continued)



# Approvals

## H.1 Overview

This appendix lists the approvals for SAILOR 900 VSAT:

- *CE (R&TTE)*
- *Eutelsat S.A – ESV Summary Sheet*

## H.2 CE (R&TTE)

The SAILOR 900 VSAT is CE certified (R&TTE directive) as stated in the “Declaration of Conformity with R&TTE Directive”, enclosed in copy on the next page.

## Thrane & Thrane A/S

### Declaration of Conformity with R&TTE Directive

The undersigned of this letter declares that the following equipment complies with the specifications of EC directive 1999/5/EC concerning Radio & Telecommunications Terminal Equipment.

#### Equipment included in this declaration

TT-7090A VSAT 900 System consisting of:

TT-7016A	SAILOR 900 Antenna Control Unit (ACU) T19"	PN = 407016A-T19 or
	SAILOR 900 Antenna Control Unit (ACU) TBH	PN = 407016A-TBH or
	S900 Antenna Control Unit (ACU) N19"	PN = 407016A-N19 or
	S900 Antenna Control Unit (ACU) NBH	PN = 407016A-NBH

And:

TT-7009A	SAILOR 900 Above Deck Unit (ADU) THR	PN = 407009A-THR or
	S900 Above Deck Unit (ADU) EDK	PN = 407009A-EDK or
	S900 Above Deck Unit (ADU) NEU	PN = 407009A-NEU

#### Equipment Applicability

TT-7090A VSAT 900 System consists of an antenna unit (ADU – Above Deck Unit) and an ACU (Antenna Control Unit). The system includes either one of the ACUs (TT-7016A 19" Rack or TT-7016A Bulkhead). VSAT=Very Small Aperture Terminal. It is a system that provides two-way satellite voice/data broadband communication while in movement on a vessel at sea (stabilized). The system can transmit to and receive from any desired Ku-band satellite, which has adequate signal coverage in the current geographic area.

#### Declaration

The requirement with respect to the LVD directive 2006/95/EC is met by conforming to the harmonized EU standard EN 60950. The protection requirement with respect to the EMC directive 2004/108/EC is met by conforming to the harmonized EU standard EN 60945. Effective use of frequency spectrum is met by conforming to harmonized EU standard EN 302 340. Confirmed by Nemko, Notified Body No. 0470.

#### Manufacturer

Thrane & Thrane A/S  
Lundtoftegårdsvej 93D, DK-2800 Kgs. Lyngby, Denmark  
Porsvej 2, DK-9200 Aalborg SV, Denmark

#### Place and Date

Kgs. Lyngby, 24. January 2012

  
Walther Thygesen, CEO  
Thrane & Thrane A/S



Doc. no. 99-133102-A

Thrane & Thrane A/S • Lundtoftegårdsvej 93 D • DK-2800 Kgs. Lyngby • Denmark  
T +45 39 55 88 00 • F +45 39 55 88 88 • info@thrane.com • www.thrane.com  
Bank: Danske Bank • Comp.reg.: 65 72 46 18 • VAT: DK-20 64 64 46



Page: 1 of 1

## H.3 Eutelsat S.A – ESV Summary Sheet

**Eutelsat s.A.**

**ESV Summary Sheet**



**Manufacturer:**

Thrane & Thrane A/S  
Lundtoftegaardsvej 93 D  
DK-2800 Kgs. Lyngby  
DENMARK

Tel: + 45 39 55 88 00  
Fax: + 45 39 55 88 88  
<mailto:info@thrane.com>

**Antenna model:**  
SAILOR 900 VSAT

**Antenna aperture dimensions:**  
1.05 m

**Standard:**  
M

**Characterization date:**  
16-11-2012

**System Description:**

Stabilised maritime antenna – ring focus Gregorian configuration – sandwich foam RTM (Resine Transfer Molding) radome. Three axis stabilization platform with conical RF tracking.  
BUC NextGenWave 8W rating  
LNB Philtech  
OMT Thrane & Thrane TT 60-131011

**Models Characterized:**

Standard configuration: linear orthogonal polarization with co-polarized or cross-polarized signal reception option.

**Maximum Allowed EIRP:**

For digital carriers transmitted at the satellite receive contour of 0 dB/K (EESS 502 refers):  
40.0 dBW / 40 KHz for an orbital separation of the adjacent satellite  $\geq 2.0^\circ$   
36.1 dBW / 40 KHz for an orbital separation of the adjacent satellite  $\geq 1.5^\circ$

**Tx Frequency:**  
13.75 – 14.50 GHz

**Rx Frequency:**  
10.7-12.75 GHz

**Tx Gain:**  
41.9 dBi (typical at 14.25 GHz)

**Rx Gain:**  
40.1 dBi (typical at 11.7 GHz)

**Tx XPD:**  
>35 dB within -1 dB contour

**Rx XPD:**  
>31.1 dB within -1 dB contour

**G/T (measured with radome)**  
19.9 dB/K @ 12.75 GHz 30 ° Elevation

**Remarks:**

1-The manufacturer states that the RMS pointing error is less than  $0.20^\circ$  for the following ship motions:

Roll =  $30^\circ$  in a period of 6 sec  
Pitch =  $15^\circ$  in a period of 4 sec  
Yaw =  $10^\circ$  in a period of 10 sec

2-The RF performance characterization was performed on one antenna unit with radome, at the France Telecom test range of La Turbie, France on the 23-25 October 2012.

3-Thrane & Thrane will insert in the ACU software a look-up table with the polarization skew of the Eutelsat satellites, to protect against the mishandling of polarization skew values by installers.

4-The characterization's validity is subject to regular submission of patterns to confirm that the system remains compliant with the Eutelsat standards.

**Restriction:**

The use of Rx band 10.7 to 10.95 GHz may be subject to impairments because the isolation of the sidelobes at  $3^\circ$  from the boresight is less than 20 dB at 10.70 GHz (16.4 dB). Nevertheless these operations may be exceptionally authorized according to a valid Eutelsat transmission plan.



## A

ABS	ADU Bus Slave
ACU	Antenna Control Unit
ADM	ACU Digital Module. A main processor board in the ACU.
AMB	Antenna Module Bus

## B

BUC	Block Up Converter - The BUC can be thought of the “transmitter”, and its actions are effectively the direct opposite to the LNB. The BUC consists of the Up Converter and HPA.
-----	---

## C

CE	Conformité Européenne. This term signifies that a CE certified product conforms to European health, environmental, and safety regulations. In short, it makes the product legal to be sold in the European Union.
CM	Continuous Monitoring

## D

DDM	DC-Motor Driver Module
DHCP	Dynamic Host Configuration Protocol. A protocol for assigning dynamic IP addresses to devices on a network. With dynamic addressing, a device can have a different IP address every time it connects to the network.
DNS	Domain Name System. A system translating server names (URLs) to server addresses.
DVB	Digital Video Broadcasting, a set of standards relating to digital television.

## E

EIRP	Effective Isotropically-Radiated Power. The amount of power that would have to be emitted by an isotropic antenna (that evenly distributes power in all directions) to produce the peak power density observed in the direction of maximum antenna gain.
ESD	ElectroStatic Discharge
ETSI	European Telecommunication Standard Institute

## F

FPGA            Field Programmable Gate Array

## G

GNSS            Global Navigation Satellite System, e.g. GPS.

GPL              General Public License

GPS              Global Positioning System. A system of satellites, computers, and receivers that is able to determine the latitude and longitude of a receiver on Earth by calculating the time difference for signals from different satellites to reach the receiver.

## H

HDT              HeaDing True, NMEA sentence.

## I

IEC              International Electrotechnical Commission. The international standards and conformity assessment body for all fields of electrotechnology.

ISM              Inertial Sensor Module

## K

KDM              Keyboard and Display Module of the ACU

## L

LAN              Local Area Network

LEN              Load Equivalent Number

LGPL             Lesser General Public License

LNB              Low Noise Block. A device used to amplify or boost the weak received signal without amplifying the noise signals (hence the “low noise” part of LNB) and to convert the high frequencies of the signal into lower frequencies, a process called down converting, for conveyance to the indoor equipment (demodulator) for processing.

LO                Local Oscillator. LO frequency used by BUC and LNB.



---

## M

MIB Management Information Base

## N

NID Network IDentification

NMEA National Marine Electronics Association (standard). A combined electrical and data specification for communication between marine electronic devices such as echo sounder, sonars, anemometer (wind speed and direction), gyrocompass, autopilot, GPS receivers and many other types of instruments. It has been defined by, and is controlled by, the U.S.-based National Marine Electronics Association.

## O

OMT Ortho Mode Transducer

openAMIP Open Antenna-Modem Interface Protocol, facilitates the exchange of information between an ACU and a satellite router. It allows the router to command the antenna and enables automatic beam switching (ABS).

## P

PAST Person Activated Self Test

PCM Pedestal Control Module

PMM Polarisation Motor Module

POST Power On Self Test. A system test that is activated each time the system is powered on.

PSM Power Supply Module

## R

RF Radio Frequency. Electromagnetic wave frequencies between about 3 kilohertz and about 300 gigahertz including the frequencies used for communications signals (radio, television, cell-phone and satellite transmissions) or radar signals.

RFI Radio Frequency Interference. A non-desired radio signal which creates noise or dropouts in the wireless system or noise in a sound system.

ROSS Roaming Oceanic Satellite Server

RSSI Received Signal Strength Indicator

## S

**SNMP** Simple Network Management Protocol. An Internet-standard protocol for managing devices on IP networks. It is used mostly in network management systems to monitor network-attached devices for conditions that warrant administrative attention.

## T

**TMA** Thrane Management Application

## U

**UCLI** User Command Line Interface

## V

**VIM** VSAT Interface Module

**VMU** VSAT Modem Unit

**VSAT** Very Small Aperture Terminal, a two-way satellite ground station or a stabilized maritime VSAT antenna with a dish antenna that is smaller than 3 metres.

## W

**WAN** Wide Area Network

## X

**XIM** Xim Interface Module, term for the module that connects the PCM and the ACU. X stands for one of various interface modules.

## Z

**ZRM** Zero Reference Module

## Numerics

10 MHz reference, 6-23

## A

access

limit, 6-41

ACU

description, 2-5

LED, 8-8

ACU display

description, 6-45

ACU events, G-8

ACU interfaces, 2-6

ACU rack version

connector panel, overview, 4-1

grounding, 3-25

installing, 3-25

LEDs, display and keypad, 4-1

administration

settings, 6-39

administrator

log off, 6-41

logon, command line interface, D-1

logon, web interface, 6-39

password, 6-40

password, change, 6-40

password, reset, 6-41

ADU

cable sizes, A-8

connector, 4-3

description, 2-2

grounding, optimal, 3-23

ADU cable

alternatives, 3-24

connection, 3-21

modem attenuation, 3-24

ADU cable loop

DC-resistance, 3-24

ADU events, G-2

aluminum hulls

grounding, F-5

antenna

drainage, 3-17

grounding recommendations, F-2

installation location, 3-3

isolation from mounting base, F-8

mast design, 3-8

obstructions, 3-4

opening, 3-22

radiation, 3-6

stabilization, 2-2

antenna cable

check condition, 6-7

antenna dish position

fix, 2-4, 8-12

approval

CE&RTTE, H-1

Eutelsat, H-3

Apstar, E-2

Astra2 satellite, E-1

attenuation

ADU cable, 3-24

attenuator margin

cable calibration, 6-7

Australia satellite, E-2

azimuth calibration, 6-3

DVB symbol rate minimum, 6-4

flow chart, 6-9

## B

baud rate

NMEA 0183, 4-4

VSAT modem, 6-23

beam switching, C-2

BITE test, 8-8

blocking zones

azimuth, 3-5

elevation, 3-5

braces

mast, 2 pieces, 3-12

mast, 3 pieces, 3-11

browser settings

for web interface, 6-15

BUC data sheet, A-11

BUC LO frequency, A-11

BUC output power, 6-18

BUC power, 6-12

**C**

## cable

- calibration data reset, 6-44
- Comtech 570 L or 625 Satellite Modem, 4-9, 4-10
- ground, F-7
- iNFINITI 5000 Series Satellite Router, 4-8
- power, 5-2
- RS-232 to Console, 4-8

## cable calibration

- attenuator margin, 6-7
- flow chart, 6-9

## cable loss

- ADU cable, 3-21

## cable requirements

- NMEA, 4-4

## cable size

- N-connector, ADU, A-8

## cable type

- LAN, 4-7

## calibration

- azimuth, 6-3, 6-6
- cable, 6-6
- elevation requirements, 6-4
- error codes, 6-8
- flow chart, 6-9
- NID, 6-4
- polarisation, 6-4
- satellite data, 6-4, 6-7, 6-20, E-1
- service profile, 6-3

## calibration data, 6-44

- enter, 6-3
- reset, 6-44

## CE&amp;RTTE approval, H-1

## change administrator password, 6-40

## Change network, 6-42

## China satellite, E-2

## command line interface, D-1

- config, D-3
- demo, D-3
- dualantenna, D-4
- exit, D-4
- help, D-2
- modem, D-5
- satellite, D-5
- status, D-7
- supported commands, D-3
- system, D-8
- track, D-8
- user name and password, D-1
- zone, D-9

## commands

- Serial, C-12

## commands in command line interface, D-3

## compass safe distance, A-4

## compression point

- P1 dB, BUC, 6-19

## COMTECH 570 L and ROSS

- examples, C-16

## Comtech 570 L or 625 Satellite Modem, 4-8, 4-10

- cable, 4-9, 4-10

## condensation in antenna, 3-17

## config

- command line interface, D-3

## configuration

- copy, 6-42
- export, 6-42
- import, 6-42
- LAN network, 6-26
- site map, 6-13
- step-by-step, 6-1

## configuration examples

- COMTECH 570L and ROSS, C-16
- Gilat SkyEdge II, C-22
- Inmarsat G5, C-23
- OpenAMIP, C-7
- Serial, C-14
- STM Satlink 2900, C-19

## Configuration program, 6-1

## connect

- Comtech 570 L or 625 Satellite Modem, 4-8,

- 4-10
- Evolution X5 Satellite Router, 4-8
- Gilat SkyEdge II, 4-10
- iNFINITI 5000 Series Satellite Router, 4-7
- power cable, 5-4
- Satlink 2900, 4-10
- web interface, 6-1
- connector
  - ADU, 4-3
  - DC, 4-2
  - DC Input, 4-2
  - LAN, 4-6
  - management PC, 4-6
  - modem control, 4-6
  - NMEA 0183/2000, 4-4
  - RS-232, 4-5
  - RS-422, 4-5
  - service port, 4-6
  - TNC, 4-3
  - VMU Rx-Tx, 4-3, 4-4
- contact information, 8-2
- corrosion
  - smoke deposits, 3-17
- country restrictions
  - VSAT, -v
- current
  - start up peak, 5-1

## D

- DC connector, 4-2
- DC Input
  - connector, 4-2
- default
  - reset to factory settings, 6-43
- default gateway, 6-28
- degradation
  - due to the radar, 3-15
  - Ku-band connection, 3-15
- demo
  - command line interface, D-3
- DHCP client, 6-27
- DHCP server, 6-27
- diagnostic report, 6-33, 8-2
- display
  - ACU, description, 6-45
- distance
  - antenna to GPS receiver, 3-15
  - antenna to radar, 3-13
- DNS setup, 6-28

- drainage of antenna, 3-17
- drawing
  - ACU rack version, A-7
  - ADU, A-6
- dual antenna
  - blocking zone, 6-37
  - cabling, 3-28
  - command line interface, D-4
  - commissioning, 6-39
  - configuration, 6-34
  - installation, 3-27
  - line up, 6-39
  - single antenna use, 6-39
- dual-antenna mode
  - slave DASHBOARD, 6-34
- DVB symbol rate
  - azimuth calibration, 6-4
- DVB-S, 6-4
- DVB-S satellite data, E-1
- DVB-S2, 6-4

## E

- elevation angle
  - minimum, 6-21
- elevation cutoff, 6-21
- E-mail setup, 6-29
- error codes, G-1
  - calibration, 6-8
- error messages, 8-2, G-1
  - ACU, G-8
  - ADU, G-2
- ETSI
  - elevation angle, 6-21
- Eutelsat
  - approval, H-3
- event, G-1
- event list
  - view, 6-44
- events
  - ACU, G-8
  - ADU, G-2
  - list of active, 8-2
- Evolution X5 Satellite Router
  - connect, 4-8
- exit
  - command line interface, D-4
- export configuration, 6-42

**F**

- factory default
  - calibration data, 6-44
  - reset, 6-43
- factory defaults
  - reset to, 8-3
- failure states
  - view, 8-14
- FCC
  - elevation angle, 6-21
- Features, 2-1
- fiberglass hulls
  - grounding, F-6
- fix antenna
  - lock, 2-4, 8-12
- fixed heading, 6-6
- fixed TX gain, 6-12
- flange thickness, 3-8
- flatness, 3-8
- flow chart
  - calibration, 6-9

**G**

- gain
  - fixed TX, 6-12
- gateway setup, 6-28
- Gilat SkyEdge II
  - connect, 4-10
  - examples, C-22
- GPS receiver
  - distance from antenna, 3-15
- grounding, F-1
  - ACU rack version, 3-25
  - ADU, 3-23
  - aluminum hulls, F-5
  - antenna, F-2
  - cable, F-7
  - fiberglass hulls, F-6
  - recommendations, F-2
  - steel hulls, F-3
  - terminal, F-2
- gusset plates, 3-8

**H**

- hatch
  - remove, 3-22

- help
  - command line interface, D-2
- humidity in antenna, 3-17

**I**

- impedance
  - cable, 5-3
  - ship, 5-2
  - total, 5-2
- import configuration, 6-42
- iNFINITI 5000 Series Satellite Router
  - cable, 4-8
  - connect, 4-7
- Inmarsat G5
  - examples, C-23
- installation
  - ACU rack versionl, 3-25
- Interfaces, 4-1, 5-1
- interference, 3-13
  - from radar, 3-13
  - RF, F-11
- IP address
  - for web interface, 6-2, 8-6
  - OpenAMIP modem, 6-23, 6-27
  - static, 6-27

**L**

- LAN
  - cable type, 4-7
  - connector, 4-6
  - network setup, 6-26
- LAN configuration
  - default gateway, 6-28
  - DHCP client, 6-27
- LAN connector
  - management, 4-6
- LAN network
  - configuration, 6-26
- LED
  - ACU, 8-8
- license
  - software, -ii
- limit access to web interface, 6-41
- Line up, 6-10

LNB  
 configuration, A-10  
 Co-pol or X-pol, 6-5  
 data sheet, A-9  
 LNB LO stability, A-9  
 LO frequencies, 6-45  
 LO frequency, A-11  
 LO stability, A-9  
 load  
 configuration, 6-42  
 lock  
 service hatch, 3-22  
 locking pin, 2-4, 8-12  
 log off  
 administrator, 6-41  
 logon  
 administrator, command line interface, D-1  
 administrator, web interface, 6-39

## M

mail server  
 setup, 6-29  
 management PC  
 connect, 4-6  
 mast  
 2 braces, 3-12  
 3 braces, 3-11  
 design, 3-8  
 flange thickness, 3-8  
 flatness, 3-8  
 foundation, 3-8  
 gusset plates, 3-8  
 height, 3-8  
 without braces, 3-11  
 mast flange, 3-8  
 mast for antenna, 3-8  
 mast length, 3-11  
 master  
 active, dual antenna, 6-34  
 Master ACU  
 dual antenna, 6-35  
 messages, G-1  
 sent from VMU, OpenAMIP, C-3  
 MIB, 6-51  
 MIB file, 6-51  
 microwave radiation, -iii  
 minimum elevation angle, 6-21  
 Model numbers, 2-8

modem  
 command line interface, D-5  
 signal level, ACU display, 6-47  
 supported types, 6-22  
 modem control  
 connector, 4-6  
 modem option file  
 Serial, C-13  
 modify XIM data, 6-42  
 motion centre  
 ship, 3-7

## N

navigation, 6-14  
 navigation in web interface, 6-15  
 N-connector  
 cable sizes, A-8  
 network  
 LAN setup, 6-26  
 NID  
 calibration, 6-4  
 NMEA  
 cable requirements, 4-4  
 connector, 4-4  
 LEN, 4-4  
 NMEA 0183  
 baud rate, 4-4  
 notifications, 8-3  
 NSS6 satellite, E-1

## O

obstructions  
 distance and size, 3-4  
 On/Off switch  
 rack version, 4-2  
 OpenAMIP  
 setup, C-2  
 supported commands, C-3  
 OpenAMIP IP modem  
 IP address, 6-23, 6-27  
 OpenAMIP keys, C-5  
 opening antenna, 3-22  
 options  
 order number, 2-8  
 options file, C-5  
 order number  
 options, 2-8

order numbers, 2-8  
outline drawing  
    ACU rack version, A-7  
    ADU, A-6  
output power  
    TX, BUC, 6-18

## P

password  
    administrator, 6-40  
    change, 6-40  
    UCLI, D-1  
PAST, 8-8  
peak current, 5-1  
permissions  
    user, 6-42  
Person Activated Self Test, 8-8  
placing the antenna, 3-3  
polarisation skew, 6-7  
pole mount, 3-8  
POST, 8-8  
power  
    sources, 5-1  
power cable  
    connect, 5-4  
    selection, 5-2  
Power On Self Test, 8-8  
power supply, 2-5  
protect access to settings, 6-41  
Proxy server, disabling, 6-15

## R

radar  
    distance from antenna, 3-13  
    signal degradation, 3-15  
radiation, -iii  
radiation level, 3-6  
reference signal, 10 MHz, 6-23  
refresh  
    browser, 6-6  
    web interface, 6-6  
remove  
    service hatch, 3-22  
report  
    send by e-mail, 6-29

reset, 6-50, 8-3  
    factory default, 6-43  
    password, 6-41  
reset administrator password, 6-41  
reset keys on ACU, 6-50  
RF interference  
    recommendations, F-11  
RF loss  
    ADU cable, maximum, 3-21  
ROAM protocol  
    ROSS, C-15  
roll period  
    limitations, 3-7  
    mounting height, 3-7  
    ship, 3-7  
ROSS box, C-15  
ROSS ROAM protocol, C-15  
RS-232  
    connector, 4-5  
RS-232 to Console  
    cable, 4-8  
RS-422  
    connector, 4-5  
Rx-Tx  
    connector, 4-3, 4-4

## S

safety summary, -iii  
samples  
    statistics, 6-30, 6-33  
sampling interval, 6-30, 6-33  
satellite  
    Singapore, E-2  
satellite  
    Apstar, E-2  
    Astra2, E-1  
    Australia, E-2  
    China, E-2  
    command line interface, D-5  
    NSS6, E-1  
    SatMex6, E-1  
    SES, E-1  
    Telstar 10, E-2  
    Telstar 11N, E-1  
    Thaicom 5, E-2  
    Thor 5 T2, E-1  
satellite data, E-1, E-2  
    calibration, 6-4, 6-7, 6-20



- Satlink 2900
    - connect, 4-10
  - SatMex6 satellite, E-1
  - save
    - configuration, 6-42
  - self test, 2-5, 8-3
  - send e-mail
    - diagnostic report, 6-33
  - Serial
    - examples, C-14
    - setup, C-11
    - supported commands, C-12
  - server setup
    - SMTP, 6-29
  - service hatch
    - lock, 3-22
    - remove, 3-22
  - service port
    - rack version, 4-2
  - service profile
    - calibration, 6-3
  - SES satellite, E-1
  - setup
    - diagnostic report, 6-33
    - e-mail, 6-29
    - for statistics report, 6-29
    - statistics report, 6-30
    - user permissions, 6-41
  - shadowing, 3-4
  - ship motion centre, 3-7
  - signal level
    - modem, ACU display, 6-47
  - Singapore satellite, E-2
  - single antenna
    - force out of dual mode, 6-39
  - site map, 6-13
  - SkyEdge II, C-20
  - slave
    - active, dual antenna, 6-34
  - Slave ACU
    - dual antenna, 6-36
  - smoke deposits, 3-17
  - SMTP
    - server, 6-29
  - SMTP login, 6-29
  - SNMP, 6-51
    - community string, 6-51
  - software license, -ii
  - software update, 8-4
    - TMA, 8-4
    - web interface, 8-6
  - software version, 1-1
    - verify, 8-7
  - source impedance
    - measuring, 5-2
  - specifications, A-1
    - ACU, A-4
    - ADU, A-2
    - BUC, A-11
    - cable Comtech VSAT modem, B-2
    - cable iDirect VSAT modem, B-3
    - LNB, A-9
  - spreadsheet
    - statistics report, 6-32
  - start-up current, 5-1
  - static IP, 6-1
  - static IP address, 6-27
  - statistics
    - sampling frequency, 6-30, 6-33
    - send by e-mail, 6-29
  - statistics report, 6-30, 6-31
    - example, 6-32
    - import into spreadsheet application, 6-32
    - setup, 6-30
  - status
    - command line interface, D-7
  - status messages, 8-8
  - steel hulls
    - grounding, F-3
  - STM Satlink 2900
    - examples, C-19
  - STM Satlink 2900 VSAT modem
    - setup, C-17, C-20
  - support
    - contact information, 8-2
  - symbol rate
    - DVB, azimuth calibration, 6-4
  - system
    - ACU reset, keys to press, 6-50
    - command line interface, D-8
  - system configuration
    - copy, 6-42
  - System messages, G-1
- ## T
- technical data, A-1
  - Telnet, D-1
  - Telstar 10, E-2
  - Telstar 11N satellite, E-1

- terminal
  - grounding recommendations, F-2
- Thaicom 5, E-2
- Thor 5 T2 satellite, E-1
- TMA
  - add search path, 8-5
  - software update, 8-4
  - software version, 8-4
  - specific software, 8-5
- TMA program, 8-4
- TNC connector, 4-3
- tools needed, 3-2
- track
  - command line interface, D-8
- troubleshooting
  - diagnostic report, 8-2
- TT number, 2-8
- TX gain
  - fixed, 6-12
- TX output power, 6-18

## U

- updating software, 8-4
- upload
  - configuration, 6-42
- user name
  - UCLI, D-1
- user permissions, 6-42
  - setup, 6-41

## V

- VMU connector, 4-3, 4-4
- VSAT modem
  - baud rate, 6-23
  - COMTECH 570 L or 625, 4-8
  - COMTECH 570L, C-15
  - Gilat SkyEdge II, C-20
  - Gilat SkyEdge II, cabling, 4-10
  - iDirect iNFINITI, C-11
  - iDirect INFINITI (OpenAMIP), C-2
  - iNFINITI, cabling, 4-7
  - Satlink2900, cabling, 4-10
  - STM Satlink 2900, C-17, C-20
  - supported types, 6-22
- VSAT modem option file
  - OpenAMIP, C-5
  - Serial, C-13

- VSAT restrictions, -v

## W

- warning messages, G-1
- warnings, 8-2
- web interface
  - browser settings, 6-15
  - connect, 6-1
  - LAN connector, 4-6
  - navigating, 6-15
  - refresh, 6-6
  - software update, 8-6
- web mmi
  - LAN connector, 4-6
- Wiring, 4-1, 5-1

## X

- XIM, 8-14
- XIM data
  - modify, 6-42

## Z

- Zeroconf, 6-28
- zone
  - command line interface, D-9



98-133400-F